

# CAT4002A, CAT4004A

## Constant Current LED Driver with 32 Dimming Levels and Rset

### Description

The CAT4002A and CAT4004A provide respectively two and four matched low dropout current sources to drive LEDs. The CAT400XA uses an external resistor RSET to set the current in the LED channels. Each LED channel includes an individual control loop allowing the device to handle a wide range of LED forward voltages while still maintaining tight current matching.

The EN/DIM logic inputs supports device enable and a digital dimming interface for setting the LED channel current with 32 linear dimming levels.

LEDs can be powered directly from a Lithium-ion battery due to the low dropout (50 mV at 20 mA) current sinks. The device is available in the tiny 8-pad UDFN 2 mm x 2 mm package with a max height of 0.55 mm, as well as the 6-lead TSOT-23 and SC-70.

### Features

- 2 and 4 LED Current Sinks with Tight Matching
- 32 Dimming Levels
- Low Dropout Driver 50 mV at 20 mA
- No Switching Noise
- Shutdown Current less than 1  $\mu$ A
- LED Current set by External Resistor
- Dimming via 1-wire EZDim™ Interface
- Thermal Shutdown Protection
- 6-lead TSOT-23, SC-70, and 8-pad UDFN 2 mm x 2 mm Packages
- These Devices are Pb-Free, Halogen Free/BFR Free and are RoHS Compliant

### Applications

- LCD Display Backlight
- Cellular Phones
- Digital Still Cameras
- Handheld Devices

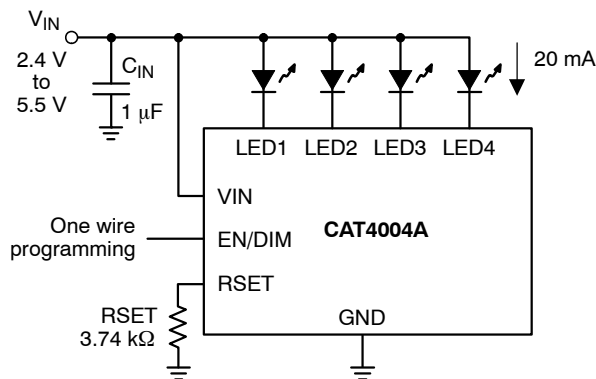

Figure 1. Typical Application Circuit



ON Semiconductor®

<http://onsemi.com>



UDFN-8  
HU2G SUFFIX  
CASE 517AW

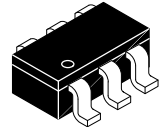

TSOT23-6  
TD SUFFIX  
CASE 419AF

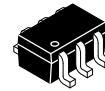

SC70-6  
SD SUFFIX  
CASE 419AD

### PIN CONNECTIONS

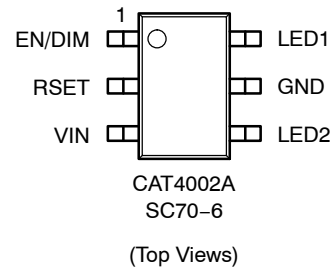
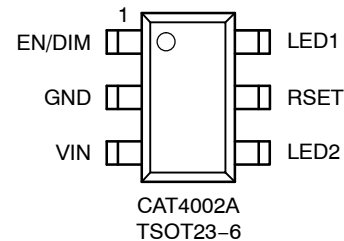
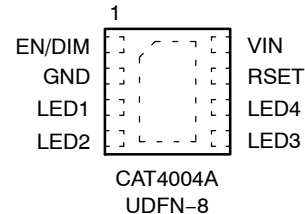

### ORDERING INFORMATION

See detailed ordering and shipping information in the package dimensions section on page 11 of this data sheet.

# CAT4002A, CAT4004A

## MARKING DIAGRAMS

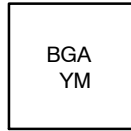

UDFN8 (2 x 2 mm)

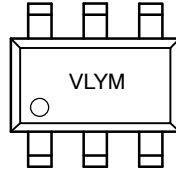

TSOT23-6

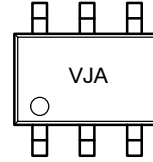

SC70-6

BG = CAT4004A Device Code  
 A = Assembly Location Code  
 Y = Production Year (last digit)  
 M = Production Month: 1 - 9, A, B, C

VL = CAT4002A Device Code  
 Y = Production Year (last digit)  
 M = Production Month: 1 - 9, A, B, C

VJ = CAT4002A Device Code  
 A = Assembly Location Code

**Table 1. ABSOLUTE MAXIMUM RATINGS**

Parameter	Rating	Unit
VIN, LEDx, RSET	6	V
EN/DIM Voltage	6	V
Storage Temperature Range	-65 to +160	°C
Junction Temperature Range	-40 to +125	°C
Lead Temperature	300	°C

Stresses exceeding Maximum Ratings may damage the device. Maximum Ratings are stress ratings only. Functional operation above the Recommended Operating Conditions is not implied. Extended exposure to stresses above the Recommended Operating Conditions may affect device reliability.

**Table 2. ELECTRICAL OPERATING CHARACTERISTICS** (Min and Max values are over recommended operating conditions unless specified otherwise. Typical values are at VIN = 4.0 V, EN/DIM = High, and Tamb = 25°C.)

Symbol	Name	Conditions	Min	Typ	Max	Units
I <sub>Q</sub>	Quiescent Current	No load, RSET = Float No load, RSET = 4.8 kΩ		0.2 0.5		mA
I <sub>QSHDN</sub>	Shutdown Current	V <sub>EN/DIM</sub> = 0 V			1	μA
I <sub>LED</sub>	LED Current Setting	RSET = 3.0 kΩ		25		mA
		RSET = 4.99 kΩ		15		
I <sub>LED-ACC</sub>	LED Current Accuracy	1 mA ≤ I <sub>LED</sub> ≤ 40 mA		±1		%
I <sub>LED-DEV</sub>	LED Channel Matching (Note 1)	$\frac{I_{LED} - I_{LEDAVG}}{I_{LEDAVG}}$	-5	±1	+5	%
V <sub>RSET</sub>	RSET pin regulated voltage		0.57	0.6	0.63	V
V <sub>DOUT</sub>	Dropout Voltage (90% of nominal LED current)	I <sub>LED</sub> = 20 mA I <sub>LED</sub> = 1 mA		50 25		mV
R <sub>EN/DIM</sub> V <sub>HI</sub> V <sub>LO</sub>	EN/DIM Pin - Internal pull-down resistor - Logic High Level - Logic Low Level		1.3	200	0.4	kΩ V V
T <sub>SD</sub>	Thermal Shutdown			150		°C
T <sub>HYS</sub>	Thermal Hysteresis			20		°C
V <sub>UVLO</sub>	Undervoltage lockout (UVLO) threshold			2.0		V

1. For CAT4004A, I<sub>LEDAVG</sub> = (I<sub>LED,CH1</sub> + I<sub>LED,CH2</sub> + I<sub>LED,CH3</sub> + I<sub>LED,CH4</sub>) / 4  
 For CAT4002A, I<sub>LEDAVG</sub> = (I<sub>LED,CH1</sub> + I<sub>LED,CH2</sub>) / 2

# CAT4002A, CAT4004A

**Table 3. RECOMMENDED OPERATING CONDITIONS**

Parameter	Rating	Unit
V <sub>IN</sub>	2.4 to 5.5	V
Ambient Temperature Range	-40 to +85	°C
I <sub>LED</sub> per LED pin	0 to 40	mA

NOTE: Typical application circuit with external components is shown on page 1.

**Table 4. RECOMMENDED EN/DIM TIMING** (For 2.4 V ≤ V<sub>IN</sub> ≤ 5.5 V, over full ambient temperature range -40°C to +85°C.)

Symbol	Name	Conditions	Min	Typ	Max	Units
T <sub>LO</sub>	EN/DIM program low time		0.2		100	μs
T <sub>HI</sub>	EN/DIM program high time		0.2			μs
T <sub>LED</sub>	LED current settling time			10		μs
T <sub>PWRDWN</sub>	EN/DIM low time to shutdown			3	5	ms

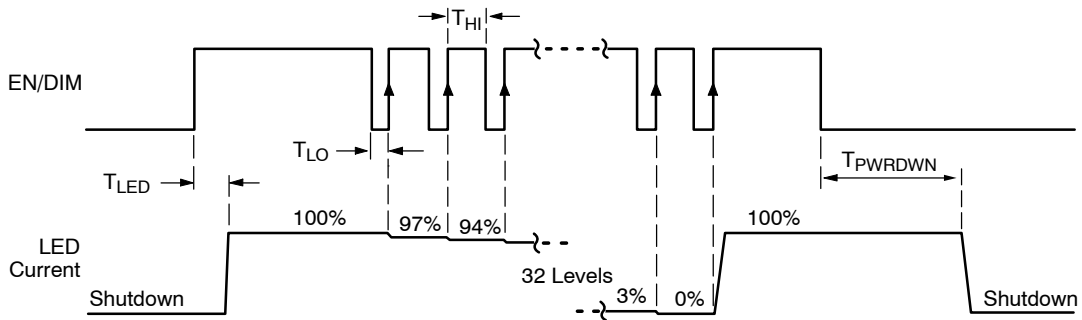

**Figure 2. CAT400XA EN/DIM Dimming Timing Diagram**

### LED Current Setting

On the CAT400XA, the full scale LED current is set by the external resistor connected between the RSET pin and ground. Table 5 lists standard resistor values for several LED current settings.

When the EN/DIM is initially taken high, the CAT400XA becomes enabled and the LED channel current is set to the full scale current according to the resistor RSET.

$$I_{LED} \cong 125 \times V_{RSET} / RSET$$

**Table 5. RSET RESISTOR AND LED CURRENT**

Full Scale LED Current [mA]	RSET [kΩ]
2	40.2
5	15.4
10	7.68
15	4.99
20	3.74
25	3.00
30	2.49
40	1.87

# CAT4002A, CAT4004A

## TYPICAL PERFORMANCE CHARACTERISTICS

(CAT4002A,  $V_{IN} = 4\text{ V}$ ,  $V_F = 3.3\text{ V}$ ,  $I_{OUT} = 50\text{ mA}$  (2 LEDs at 25 mA),  $C_{IN} = 1\text{ }\mu\text{F}$ ,  $T_{AMB} = 25^\circ\text{C}$  unless otherwise specified.)

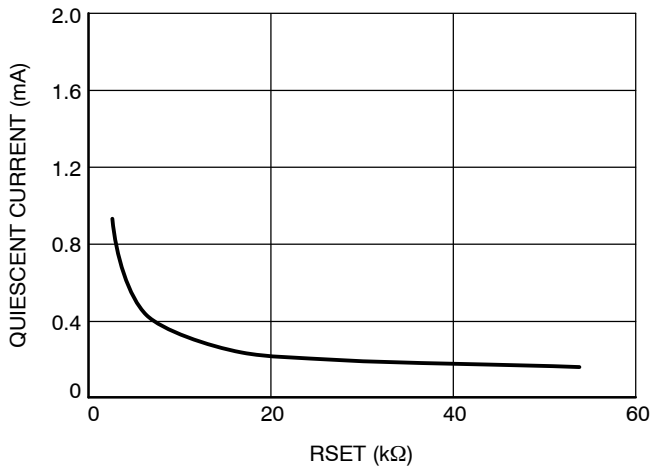

**Figure 3. Quiescent Current vs. RSET Input Voltage**

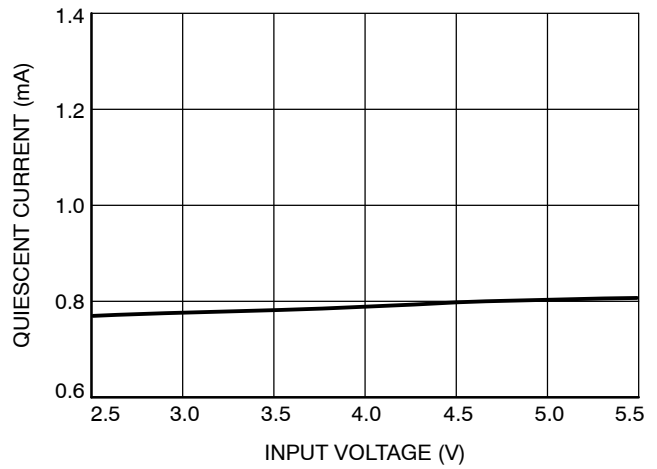

**Figure 4. Quiescent Current vs. Input Voltage (Full Load)**

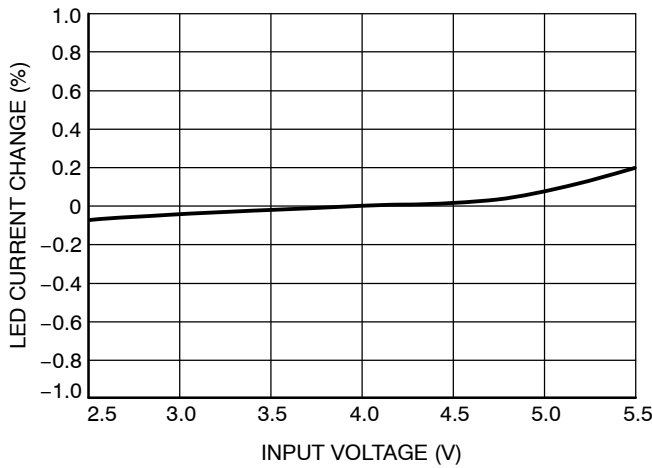

**Figure 5. LED Current Change vs. Input Voltage**

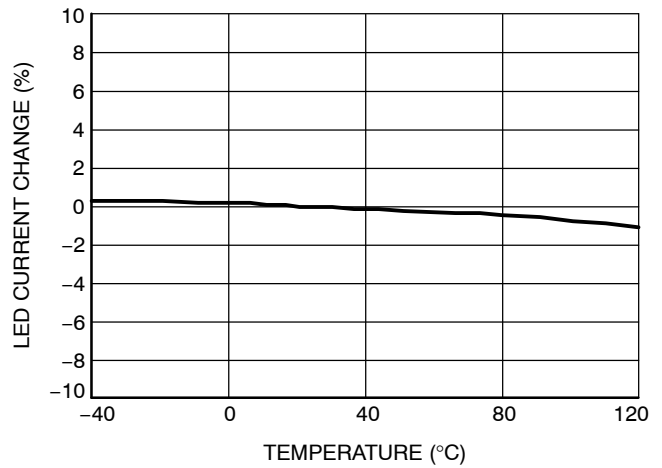

**Figure 6. LED Current Change vs. Temperature**

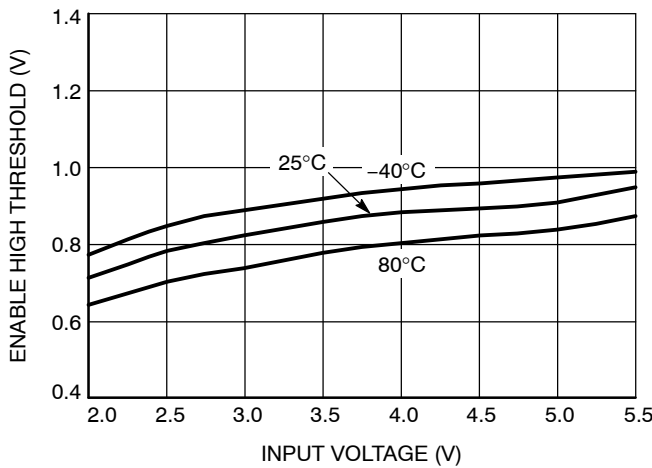

**Figure 7. EN/DIM High Threshold vs. Input Voltage**

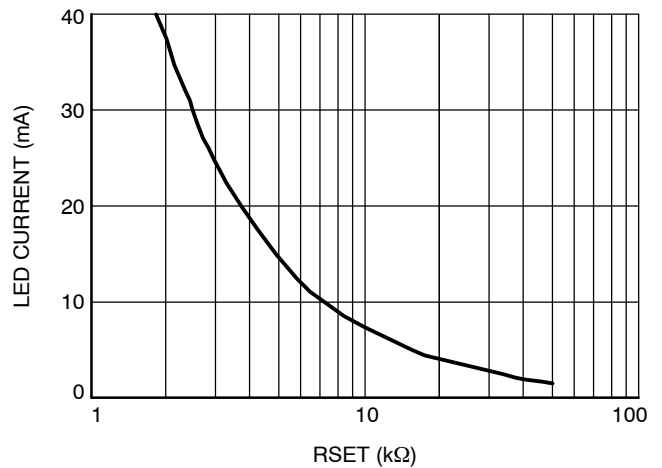

**Figure 8. LED Current vs. RSET Resistor**

# CAT4002A, CAT4004A

## TYPICAL PERFORMANCE CHARACTERISTICS

(CAT4002A,  $V_{IN} = 4\text{ V}$ ,  $V_F = 3.3\text{ V}$ ,  $I_{OUT} = 50\text{ mA}$  (2 LEDs at 25 mA),  $C_{IN} = 1\text{ }\mu\text{F}$ ,  $T_{AMB} = 25^\circ\text{C}$  unless otherwise specified.)

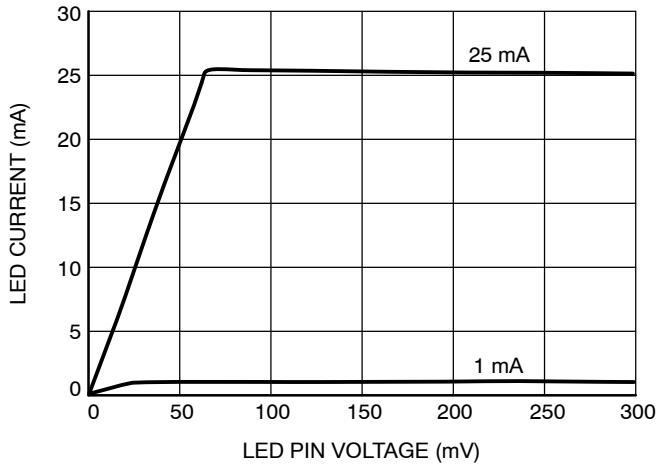

Figure 9. Dropout Characteristics

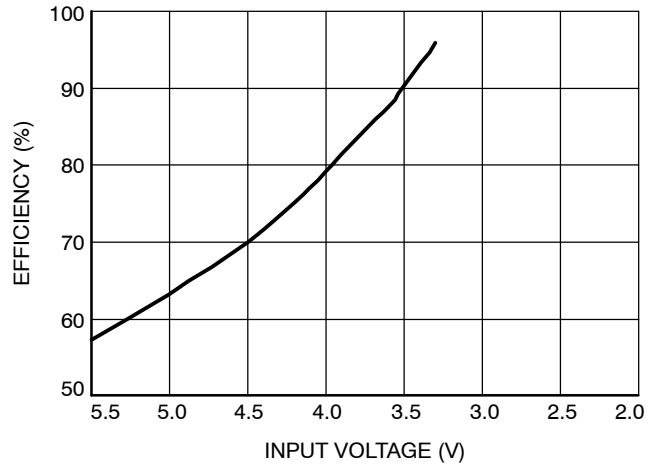

Figure 10. Efficiency vs. Input Voltage

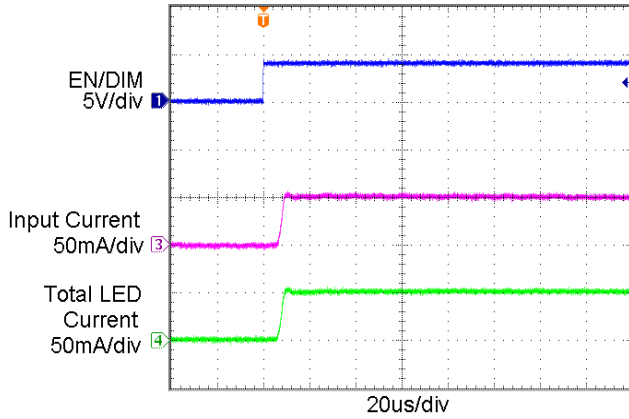

Figure 11. Power Up Waveform

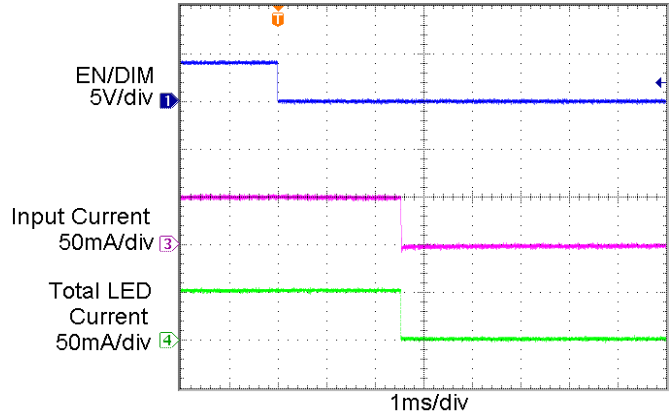

Figure 12. Power Down Waveform

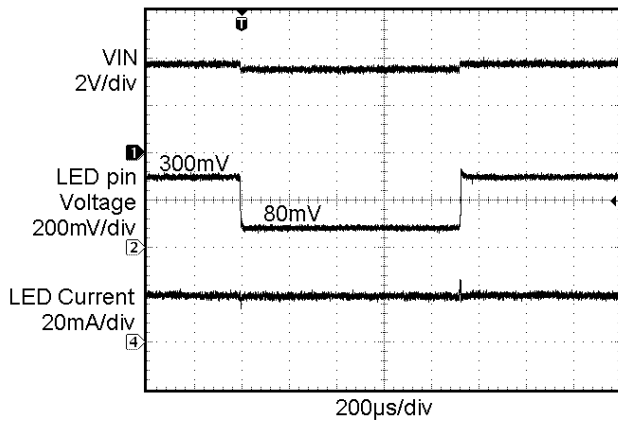

Figure 13. Line Transient Waveform

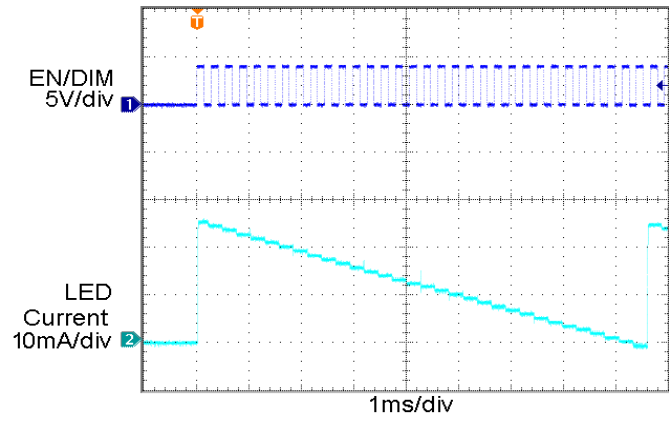

Figure 14. Dimming Levels

# CAT4002A, CAT4004A

**Table 6. PIN DESCRIPTIONS**

Name	Function
EN/DIM	Device enable (active high) and dimming control
GND	Ground reference
LED1	LED1 cathode terminal
LED2	LED2 cathode terminal
LED3	LED3 cathode terminal (CAT4004A only)
LED4	LED4 cathode terminal (CAT4004A only)
RSET	Connect external RSET resistor to set the LED current
VIN	Device supply input, connect to battery or supply
TAB	Connect to GND on the PCB (CAT4004A only)

### Pin Function

**VIN** is the supply pin for the charge pump. A small 1  $\mu$ F ceramic bypass capacitor is required between the VIN pin and ground near the device. The operating input voltage range is from 2.5 V to 5.5 V. Whenever the input supply falls below the under-voltage threshold (2.0 V), all the LED channels are disabled and the device enters shutdown mode.

**EN/DIM** is the enable and one wire dimming input for all LED channels. Levels of logic high and logic low are set at 1.3 V and 0.4 V respectively. When EN/DIM is initially taken high, the CAT400XA becomes enabled and the LED channel current is set to the full scale according to the resistor  $R_{SET}$ . To place the device into “zero current” shutdown mode, the EN/DIM pin must be held low for 3 ms typical.

**LED1 to LED4** provide the internal regulated current for each of the LED cathodes. These pins enter a high impedance zero current state whenever the device is placed in shutdown mode.

**RSET** is connected to the resistor ( $R_{SET}$ ) to set the full scale current for the LEDs. The voltage at this pin is regulated to 0.6 V. The ground side of the external resistor should be star connected back to the GND of the PCB. In shutdown mode, the RSET input becomes high impedance.

**GND** is the ground reference for the device. The pin must be connected to the ground plane on the PCB.

**TAB** (CAT4004A only) is the exposed pad underneath the package. For best thermal performance, the tab should be soldered to the PCB and connected to the ground plane.

### Block Diagram

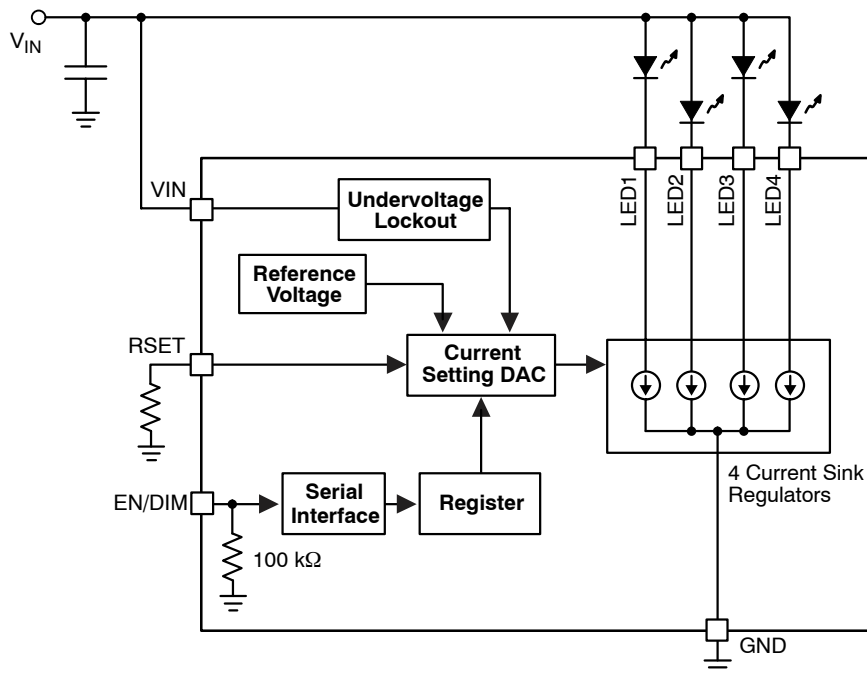

**Figure 15. CAT4004A Functional Block Diagram**

# CAT4002A, CAT4004A

## Basic Operation

The CAT400XA uses tightly matched current sinks to accurately regulate LED current in each channel proportional to the current sourced from the RSET pin.

There are 32 different settings for LED brightness that can be programmed through the EN/DIM pin. Tight current regulation for all channels is possible over a wide range of input and LED voltages due to independent current sensing circuitry on each channel.

Each LED channel needs a minimum of 50 mV headroom to sink a constant regulated current of 20 mA. If the input supply falls below 2.0 V typical, the under-voltage lockout circuit disables all LED channels and resets the circuit to default values. Any unused LED channels should be left open.

## LED Current Selection

After power-up, the LED current is set by the external resistor ( $R_{SET}$ ) value and the number of pulses (n) on the EN/DIM input as follows:

$$\text{LED current} = 125 \times \frac{0.6 \text{ V}}{R_{SET}} \times \left( \frac{31 - n}{31} \right)$$

The full scale current is calculated from the above formula with n equal to zero.

The EN/DIM pin has two primary functions. One function enables and disables the device. The other function is LED current dimming with 32 different levels by pulsing the input signal, as shown on Figure 16. On each consecutive pulse rising edge, the LED current is decreased by about 3.2% (1/31<sup>th</sup> of the full scale value). After 30 pulses, the LED current is 3.2% of the full scale current. On the 31<sup>st</sup> pulse, the current drops to zero, and then goes back to full scale on the following pulse.

Each pulse width should be between 200 ns and 100  $\mu$ s. Pulses faster than the minimum  $T_{LO}$  may be ignored and filtered by the device. Pulses longer than the maximum  $T_{LO}$  may shutdown the device. By pulsing the EN/DIM signal at high frequency, the LED current can quickly be set to zero.

The LED driver enters a “zero current” shutdown mode if EN/DIM is held low for 3 ms typical.

The dimming level is set by the number of pulses on the EN/DIM after the power-up, as shown in Table 7.

Table 7. DIMMING LEVELS

Full Scale (Current in %)	Dimming Pulses [n]
100	0
97	1
94	2
90	3
87	4
84	5
81	6
77	7
74	8
71	9
68	10
65	11
61	12
58	13
55	14
52	15
48	16
45	17
42	18
39	19
35	20
32	21
29	22
26	23
23	24
19	25
16	26
13	27
10	28
6	29
3	30
0	31
100	32

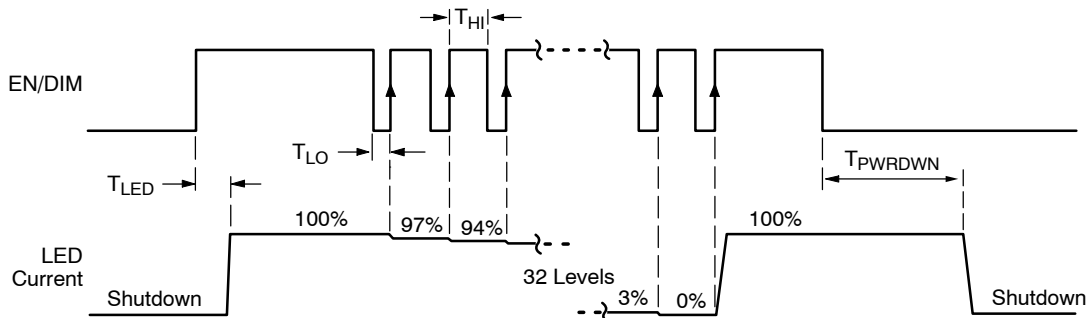
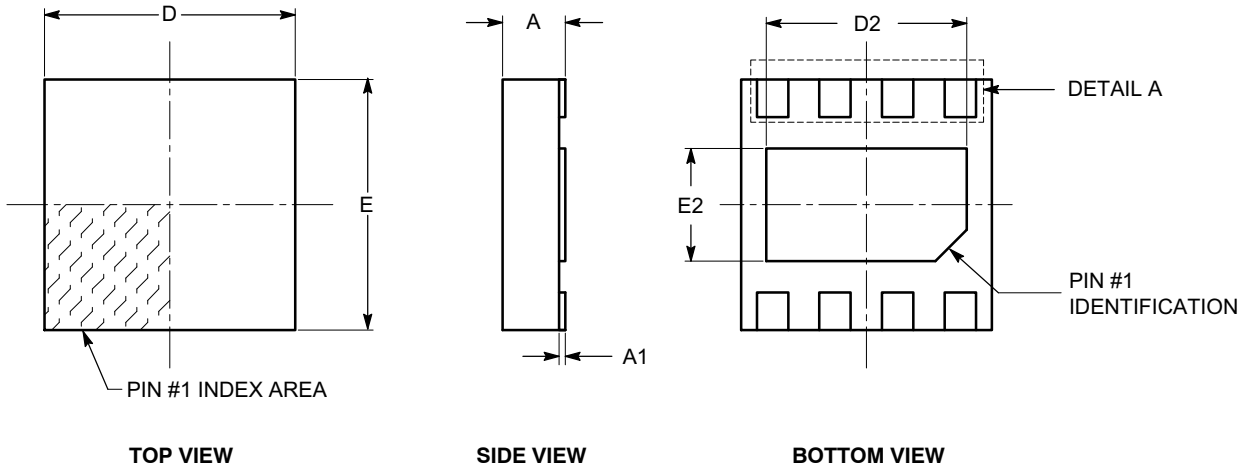

Figure 16. EN/DIM Digital Dimming Timing Diagram

# CAT4002A, CAT4004A

## PACKAGE DIMENSIONS

UDFN8, 2x2  
CASE 517AW-01  
ISSUE O



SYMBOL	MIN	NOM	MAX
A	0.45	0.50	0.55
A1	0.00	0.02	0.05
b	0.18	0.25	0.30
D	1.90	2.00	2.10
D2	1.50	1.60	1.70
E	1.90	2.00	2.10
E2	0.80	0.90	1.00
e	0.50 BSC		
L	0.20	0.30	0.45

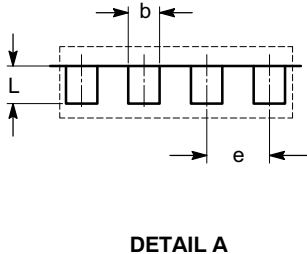

**Notes:**

- (1) All dimensions are in millimeters.
- (2) Complies with JEDEC MO-229.



# CAT4002A, CAT4004A

## PACKAGE DIMENSIONS

SC-70, 6 Lead, 1.25x2  
 CASE 419AD-01  
 ISSUE O

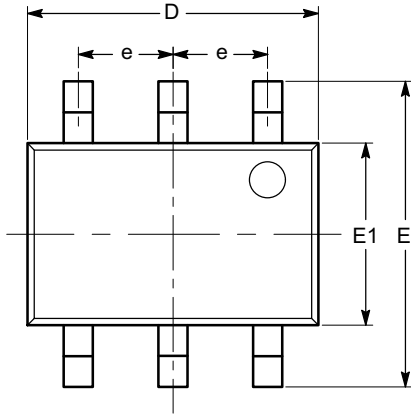

TOP VIEW

SYMBOL	MIN	NOM	MAX
A	0.80		1.10
A1	0.00		0.10
A2	0.80		1.00
b	0.15		0.30
c	0.10		0.18
D	1.80	2.00	2.20
E	1.80	2.10	2.40
E1	1.15	1.25	1.35
e	0.65 BSC		
L	0.26	0.36	0.46
L1	0.42 REF		
L2	0.15 BSC		
$\theta$	0°		8°
$\theta1$	4°		10°

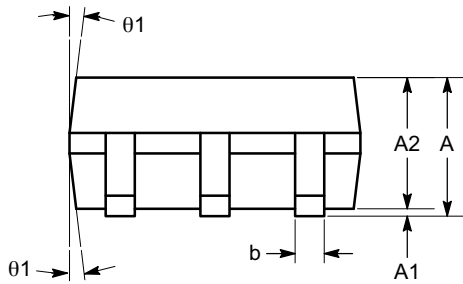

SIDE VIEW

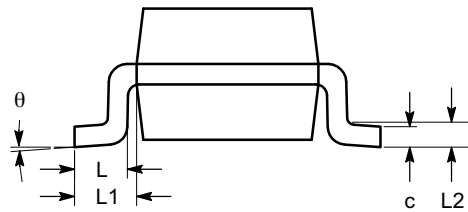

END VIEW

**Notes:**

- (1) All dimensions are in millimeters. Angles in degrees.
- (2) Complies with JEDEC MO-203.

# CAT4002A, CAT4004A

## PACKAGE DIMENSIONS

TSOT-23, 6 LEAD  
CASE 419AF-01  
ISSUE O

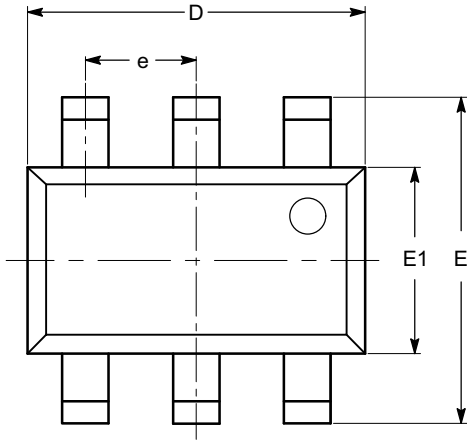

TOP VIEW

SYMBOL	MIN	NOM	MAX
A			1.00
A1	0.01	0.05	0.10
A2	0.80	0.87	0.90
b	0.30		0.45
c	0.12	0.15	0.20
D	2.90 BSC		
E	2.80 BSC		
E1	1.60 BSC		
e	0.95 TYP		
L	0.30	0.40	0.50
L1	0.60 REF		
L2	0.25 BSC		
$\theta$	0°		8°

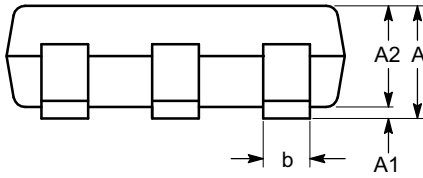

SIDE VIEW

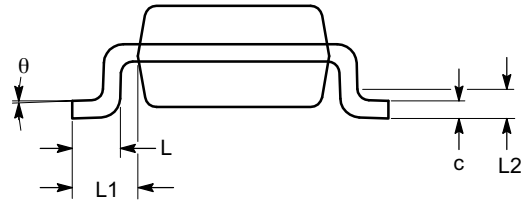

END VIEW

**Notes:**

- (1) All dimensions are in millimeters. Angles in degrees.
- (2) Complies with JEDEC MO-193.

# CAT4002A, CAT4004A

## Example of Ordering Information (Note 4)

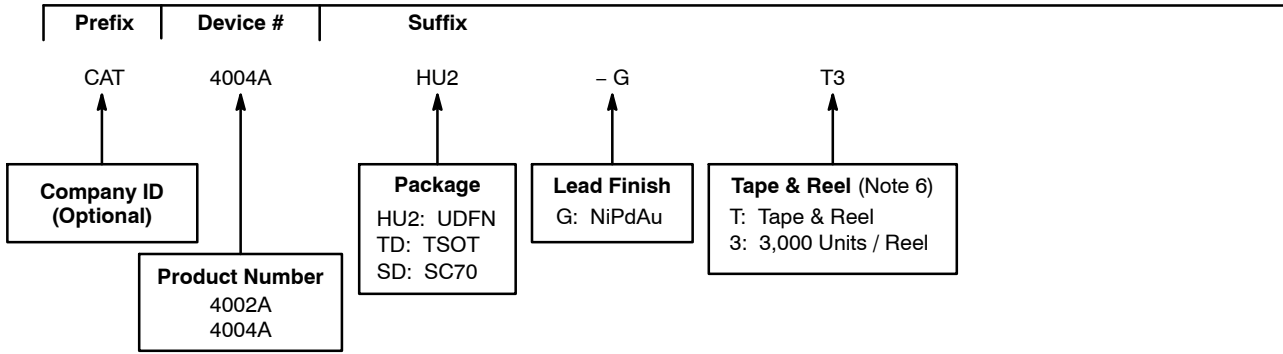

**Table 8. ORDERING INFORMATION**

Part Number	Package	Quantity per Reel
CAT4002ASD-GT3	SC70-6	3,000
CAT4002ATD-GT3	TSOT-23	3,000
CAT4004AHU2-GT3	UDFN-8 (2 x 2 mm)	3,000

- All packages are RoHS-compliant (Lead-free, Halogen-free).
- The standard lead finish is NiPdAu.
- The device used in the above example is a CAT4004AHU2-GT3 (UDFN, NiPdAu, Tape & Reel, 3,000/Reel).
- For additional package and temperature options, please contact your nearest ON Semiconductor Sales office.
- For information on tape and reel specifications, including part orientation and tape sizes, please refer to our Tape and Reel Packaging Specifications Brochure, BRD8011/D.

ON Semiconductor and  are registered trademarks of Semiconductor Components Industries, LLC (SCILLC). SCILLC reserves the right to make changes without further notice to any products herein. SCILLC makes no warranty, representation or guarantee regarding the suitability of its products for any particular purpose, nor does SCILLC assume any liability arising out of the application or use of any product or circuit, and specifically disclaims any and all liability, including without limitation special, consequential or incidental damages. "Typical" parameters which may be provided in SCILLC data sheets and/or specifications can and do vary in different applications and actual performance may vary over time. All operating parameters, including "Typicals" must be validated for each customer application by customer's technical experts. SCILLC does not convey any license under its patent rights nor the rights of others. SCILLC products are not designed, intended, or authorized for use as components in systems intended for surgical implant into the body, or other applications intended to support or sustain life, or for any other application in which the failure of the SCILLC product could create a situation where personal injury or death may occur. Should Buyer purchase or use SCILLC products for any such unintended or unauthorized application, Buyer shall indemnify and hold SCILLC and its officers, employees, subsidiaries, affiliates, and distributors harmless against all claims, costs, damages, and expenses, and reasonable attorney fees arising out of, directly or indirectly, any claim of personal injury or death associated with such unintended or unauthorized use, even if such claim alleges that SCILLC was negligent regarding the design or manufacture of the part. SCILLC is an Equal Opportunity/Affirmative Action Employer. This literature is subject to all applicable copyright laws and is not for resale in any manner.

## PUBLICATION ORDERING INFORMATION

### LITERATURE FULFILLMENT:

Literature Distribution Center for ON Semiconductor  
P.O. Box 5163, Denver, Colorado 80217 USA  
Phone: 303-675-2175 or 800-344-3860 Toll Free USA/Canada  
Fax: 303-675-2176 or 800-344-3867 Toll Free USA/Canada  
Email: [orderlit@onsemi.com](mailto:orderlit@onsemi.com)

**N. American Technical Support:** 800-282-9855 Toll Free  
USA/Canada  
**Europe, Middle East and Africa Technical Support:**  
Phone: 421 33 790 2910  
**Japan Customer Focus Center**  
Phone: 81-3-5773-3850

**ON Semiconductor Website:** [www.onsemi.com](http://www.onsemi.com)

**Order Literature:** <http://www.onsemi.com/orderlit>

For additional information, please contact your local Sales Representative