



Grayhill, Inc.

62S11-H9-040S

Zenbakiaren zenbakia:

Fabrikatzaileak / Marka:

Produktuaren Deskribapena

Fitxak:

RoHS egoera

Ontziatik aurrera

Bidalketa Bidea

62S11-H9-040S

Grayhill, Inc.

ROTARY ENCODER OPTICAL 32PPR

 62S11-H9-040S.pdf

 Lead free / RoHS betez

Hong Kong

DHL/Fedex/TNT/UPS/EMS

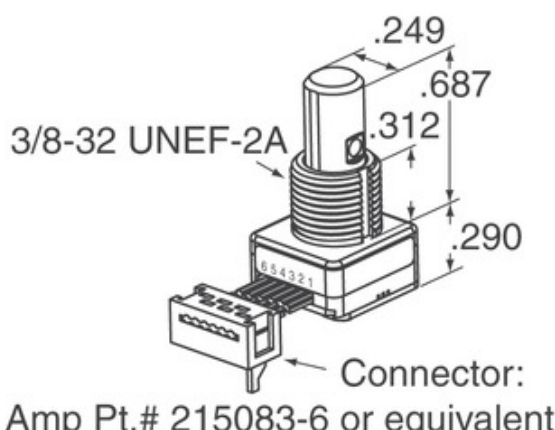

AURREKONTUEN ESKAERA

Irudia ordezkaritza izan daiteke. Ikusi produktuaren zehetasunetarako zehaztapenak.



62S11-H9-040Sren zehaztapenak

ZENBAKIAREN ZENBAKIA	62S11-H9-040S
FABRIKATZAILEA	Grayhill, Inc.
DESKRIBAPENA	ROTARY ENCODER OPTICAL 32PPR
LEAD FREE STATUS / ROHS EGOERA	Lead free / RoHS betez
DATUEN FITXA	 62S11-H9-040S.pdf
TENTSIOA - HORNIDURA	5V
AMAIERA ESTILOA	Cable Leads
SERIES	62S
BIRAKETA-BIZITZA (ZIKLOAK)	1M
IRAULTZA BAKOITZEKO LEKALEAK	32
IRTEERAKO MOTA	Quadrature (Incremental)
BESTE IZENAK	62S11H9040S
ORIENTAZIO	Vertical
MUNTAKETA MOTA	Panel Mount
HEZETASUNAREN SENTIKORTASUN MAILA (MSL)	1 (Unlimited)
FABRIKATZAILEAREN LEAD TIME ESTANDARRA	8 Weeks
LEAD FREE STATUS / ROHS EGOERA	Lead free / RoHS Compliant
KODETZAILE MOTA	Optical
DETENT	Yes
ALDATU ZEN	Yes
EKINTZA MOTA	1/4" Dia Flatted End

Erlazionatutako etiketak

Grayhill, Inc. 62S11-H9-040S	62S11-H9-040S banatzailea	62S11-H9-040S hornitzailea
62S11-H9-040S prezioa	62S11-H9-040S Irudiak	62S11-H9-040S irudia
62S11-H9-040S PDF Fitxa	62S11-H9-040S Deskargatu Fitxa	62S11-H9-040S Fitxa-orria
62S11-H9-040S Stock	Erosi 62S11-H9-040S	Erosi Grayhill, Inc. 62S11-H9-040S
Grayhill, Inc. 62S11-H9-040S	Grayhill, Inc. hornitzailea	Grayhill, Inc. Banatzailea
Grayhill, Inc. 62S11-H9-040S	Grayhill Inc. 62S11-H9-040S	

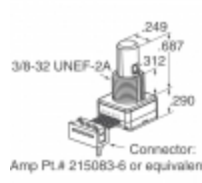
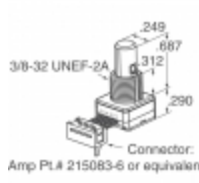
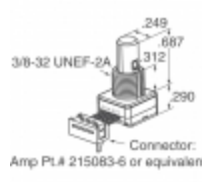
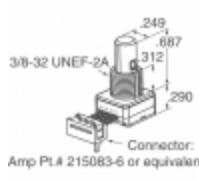
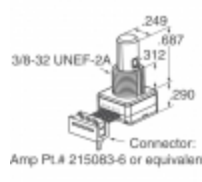
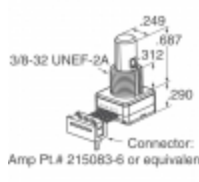
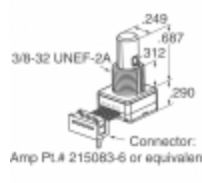
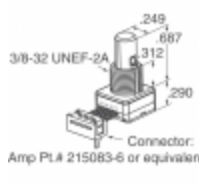
Produktu erlazioatuak

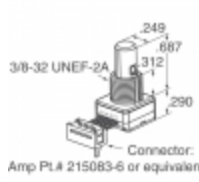
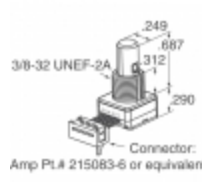
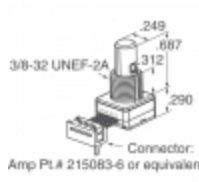
 <p>62S11-H9-060C fabrikatzaileak: Grayhill, Inc. deskribapena: ROTARY ENCODER OPTICAL 32PPR Stockean: Out stock</p> <p>RFQ</p>	 <p>62S11-H9-050S fabrikatzaileak: Grayhill, Inc. deskribapena: ROTARY ENCODER OPTICAL 32PPR Stockean: Out stock</p> <p>RFQ</p>
 <p>62S11-H0-PH fabrikatzaileak: Grayhill, Inc. deskribapena: ROTARY ENCODER OPTICAL 32PPR Stockean: Out stock</p> <p>RFQ</p>	 <p>62S11-H9-025S fabrikatzaileak: Grayhill, Inc. deskribapena: ROTARY ENCODER OPTICAL 32PPR Stockean: Out stock</p> <p>RFQ</p>
 <p>62S11-H9-060SH fabrikatzaileak: Grayhill, Inc. deskribapena: ROTARY ENCODER OPTICAL 32PPR Stockean: Out stock</p> <p>RFQ</p>	 <p>62S11-L0-020C fabrikatzaileak: Grayhill, Inc. deskribapena: ROTARY ENCODER OPTICAL 32PPR Stockean: Out stock</p> <p>RFQ</p>
 <p>62S11-H9-020C fabrikatzaileak: Grayhill, Inc. deskribapena: ROTARY ENCODER OPTICAL 32PPR Stockean: Out stock</p> <p>RFQ</p>	 <p>62S11-H9-040C fabrikatzaileak: Grayhill, Inc. deskribapena: ROTARY ENCODER OPTICAL 32PPR Stockean: Out stock</p> <p>RFQ</p>
 <p>62S11-H0-P fabrikatzaileak: Grayhill, Inc. deskribapena: ROTARY ENCODER OPT 32PPR 10" CBL Stockean: Out stock</p> <p>RFQ</p>	 <p>62S11-H9-P fabrikatzaileak: Grayhill, Inc. deskribapena: ROTARY ENCODER OPTICAL 32PPR Stockean: Out stock</p> <p>RFQ</p>
 <p>62S11-H9-020S fabrikatzaileak: Grayhill, Inc. deskribapena: ROTARY ENCODER OPTICAL 32PPR Stockean: Out stock</p> <p>RFQ</p>	 <p>62S11-H9-PH fabrikatzaileak: Grayhill, Inc. deskribapena: ROTARY ENCODER OPTICAL 32PPR Stockean: Out stock</p> <p>RFQ</p>