





Coto Technology

## 9001-12-11

Zenbakiaren zenbakia:  
 Fabrikatzaileak / Marka:  
 Produktuaren Deskribapena  
 Fitxak:  
 RoHS egoera  
 Ontziatik aurrera  
 Bidalketa Bidea

9001-12-11  
 Coto Technology  
 RELAY REED SPST 500MA 12V  
 9001-12-11.pdf  
 Lead free / RoHS betez  
 Hong Kong  
 DHL/Fedex/TNT/UPS/EMS

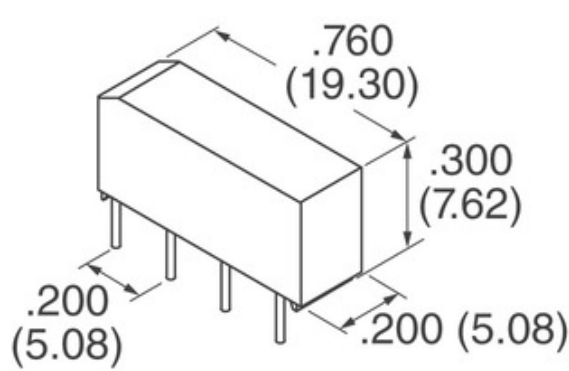

## AURREKONTUEN ESKAERA

Irudia ordezkaritza izan daiteke. Ikusi produktuaren zehetasunetarako zehaztapenak.













## 9001-12-11ren zehaztapenak

ZENBAKIAREN ZENBAKIA	9001-12-11
FABRIKATZAILEA	Coto Technology
DESKRIBAPENA	RELAY REED SPST 500MA 12V
LEAD FREE STATUS / ROHS EGOERA	Lead free / RoHS betez
DATUEN FITXA	 9001-12-11.pdf
AKTIBATU TENTSIOA (GEHIENEZ)	9 VDC
AKTIBATU TENTSIOA (GUTXIENEZ)	1 VDC
AMAIERA ESTILOA	PC Pin
TENTSIO ALDATZEA	200VAC, 200VDC - Max
SERIES	9000
ASKATU ORDUA	0.1ms
PACKAGING	Tube
TENPERATURA OPERATIBOA	-20°C ~ 85°C
DENBORA ERAGILEA	0.35ms
MUNTAKETA MOTA	Through Hole
HEZETASUNAREN SENTIKORTASUN MAILA (MSL)	1 (Unlimited)
FABRIKATZAILEAREN LEAD TIME ESTANDARRA	20 Weeks
LEAD FREE STATUS / ROHS EGOERA	Lead free / RoHS Compliant
EZAUGARRIAK	Diode, Magnetic Shield
KONTAKTUEN BALORAZIOA (ORAINGO)	500mA
HARREMANETARAKO MATERIALA	-
HARREMANETARAKO FORMULARIOA	SPST-NO (1 Form A)
BOBINA TENTSIOA	12VDC
BOBINA MOTA	Non Latching
BOBINA ERRESISTENTZIA	1 kOhms
COIL POWER	-
BOBINA KORRONTEA	12.0mA

## Erlazionatutako etiketak

Coto Technology 9001-12-11	9001-12-11 banatzailea	9001-12-11 hornitzailea
9001-12-11 prezioa	9001-12-11 Irudiak	9001-12-11 irudia
9001-12-11 PDF Fitxa	9001-12-11 Deskargatu Fitxa	9001-12-11 Fitxa-orria
9001-12-11 Stock	Erosi 9001-12-11	Erosi Coto Technology 9001-12-11
Coto Technology 9001-12-11	Coto Technology hornitzailea	Coto Technology Banatzailea
Coto Technology 9001-12-11		

## Produktu erlazioatuak

 <p><b>900103X082CN</b>          fabrikatzaileak: VCC (Visual Communications Company)          deskribapena: LED CARTRIDGE 14V 80MA SHORT CYL          Stockean: Out stock</p> <p><b>RFQ</b></p>	 <p><b>9001-100-1081</b>          fabrikatzaileak: API Technologies Corp.          deskribapena: FILTER LC(PI) 2.8UF CHASSIS          Stockean: 4 pcs</p> <p><b>RFQ</b></p>
 <p><b>9001-125</b>          fabrikatzaileak: E-T-A          deskribapena: SENSOR CURRENT SWITCH 125A DC          Stockean: Out stock</p> <p><b>RFQ</b></p>	 <p><b>9001-100-1025</b>          fabrikatzaileak: API Technologies Corp.          deskribapena: FILTER LC(PI) 0.3UF CHASSIS          Stockean: Out stock</p> <p><b>RFQ</b></p>
 <p><b>9001-150</b>          fabrikatzaileak: E-T-A          deskribapena: SENSOR CURRENT SWITCH 150A DC          Stockean: Out stock</p> <p><b>RFQ</b></p>	 <p><b>900102X082CN</b>          fabrikatzaileak: VCC (Visual Communications Company)          deskribapena: LED CARTRIDGE 6.3V 200MA CYL          Stockean: Out stock</p> <p><b>RFQ</b></p>
 <p><b>9001-12-10</b>          fabrikatzaileak: Coto Technology          deskribapena: RELAY REED SPST 500MA 12V          Stockean: 185 pcs</p> <p><b>RFQ</b></p>	 <p><b>900103X081RN</b>          fabrikatzaileak: VCC (Visual Communications Company)          deskribapena: LED CARTRIDGE RED 14V 80MA CYL          Stockean: Out stock</p> <p><b>RFQ</b></p>
 <p><b>9001-12-01</b>          fabrikatzaileak: Coto Technology          deskribapena: RELAY REED SPST 500MA 12V          Stockean: Out stock</p> <p><b>RFQ</b></p>	 <p><b>9001-12-00</b>          fabrikatzaileak: Coto Technology          deskribapena: RELAY REED SPST 500MA 12V          Stockean: Out stock</p> <p><b>RFQ</b></p>
 <p><b>900104X071WN</b>          fabrikatzaileak: VCC (Visual Communications Company)          deskribapena: LED CARTRIDGE WHT 28V 40MA CYL          Stockean: Out stock</p> <p><b>RFQ</b></p>	 <p><b>9001-100-1080</b>          fabrikatzaileak: API Technologies Corp.          deskribapena: FILTER LC(PI) 2.8UF CHASSIS          Stockean: Out stock</p> <p><b>RFQ</b></p>