



Grayhill, Inc.

62S11-H9-060SH

Zenkakiaren zenbakia:

Fabrikatzaileak / Marka:

Produktuaren Deskribapena

Fitxak:

RoHS egoera

Ontziatik aurrera

Bidalketa Bidea

62S11-H9-060SH

Grayhill, Inc.

ROTARY ENCODER OPTICAL 32PPR

[PDF 62S11-H9-060SH.pdf](#)
 Lead free / RoHS betez

Hong Kong

DHL/Fedex/TNT/UPS/EMS

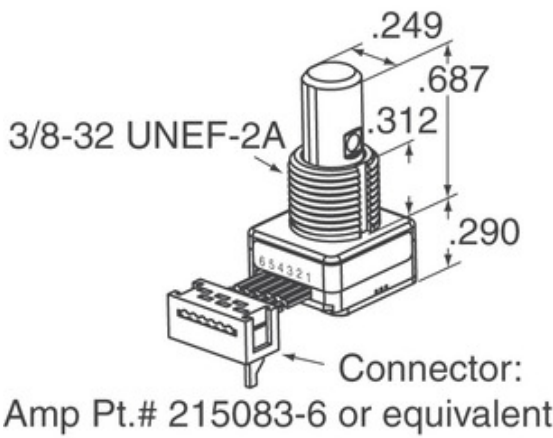
[AURREKONTUEN ESKAERA](#)

Irudia ordezkaritza izan daiteke. Ikusi produktuaren zehetasunetarako zehaztapenak.



62S11-H9-060SHren zehaztapenak

ZENBAKIAREN ZENBAKIA	62S11-H9-060SH
FABRIKATZAILEA	Grayhill, Inc.
DESKRIBAPENA	ROTARY ENCODER OPTICAL 32PPR
LEAD FREE STATUS / ROHS EGOERA	Lead free / RoHS betez
DATUEN FITXA	PDF 62S11-H9-060SH.pdf
TENTSIOA - HORNIDURA	5V
AMAIERA ESTILOA	Cable Leads
SERIES	62S
BIRAKETA-BIZITZA (ZIKLOAK)	1M
IRAULTZA BAKOITZEKO LEKALEAK	32
IRTEERAKO MOTA	Quadrature (Incremental)
BESTE IZENAK	62S11H9060SH
ORIENTAZIO	Vertical
MUNTAKETA MOTA	Panel Mount
HEZETASUNAREN SENTIKORTASUN MAILA (MSL)	1 (Unlimited)
FABRIKATZAILEAREN LEAD TIME ESTANDARRA	8 Weeks
LEAD FREE STATUS / ROHS EGOERA	Lead free / RoHS Compliant
KODETZAILE MOTA	Optical
DETENT	Yes
ALDATU ZEN	Yes
EKINTZA MOTA	1/4" Dia Flatted End

Erlazionatutako etiketak

Grayhill, Inc. 62S11-H9-060SH	62S11-H9-060SH banatzailea	62S11-H9-060SH hornitzailea
62S11-H9-060SH prezioa	62S11-H9-060SH Irudiak	62S11-H9-060SH irudia
62S11-H9-060SH PDF Fitxa	62S11-H9-060SH Deskargatu Fitxa	62S11-H9-060SH Fitxa-orria
62S11-H9-060SH Stock	Erosi 62S11-H9-060SH	Erosi Grayhill, Inc. 62S11-H9-060SH
Grayhill, Inc. 62S11-H9-060SH	Grayhill, Inc. hornitzailea	Grayhill, Inc. Banatzailea
Grayhill, Inc. 62S11-H9-060SH	Grayhill Inc. 62S11-H9-060SH	

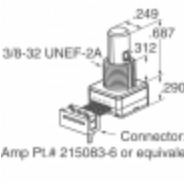
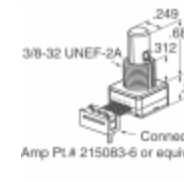
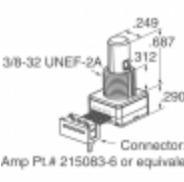
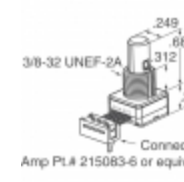
Produktu erlazioatuak

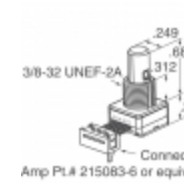
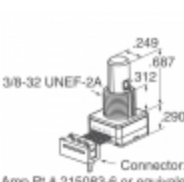
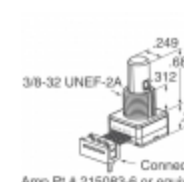
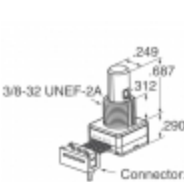
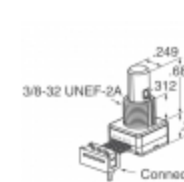
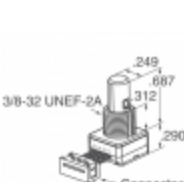
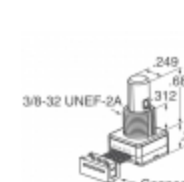
 <p>62S11-L0-040C fabrikatzaileak: Grayhill, Inc. deskribapena: ROTARY ENCODER OPTICAL 32PPR Stockean: Out stock</p> <p>RFQ</p>	 <p>62S11-H9-050S fabrikatzaileak: Grayhill, Inc. deskribapena: ROTARY ENCODER OPTICAL 32PPR Stockean: Out stock</p> <p>RFQ</p>
 <p>62S11-L0-020C fabrikatzaileak: Grayhill, Inc. deskribapena: ROTARY ENCODER OPTICAL 32PPR Stockean: Out stock</p> <p>RFQ</p>	 <p>62S11-L0-020CH fabrikatzaileak: Grayhill, Inc. deskribapena: ROTARY ENCODER OPTICAL 32PPR Stockean: Out stock</p> <p>RFQ</p>
 <p>62S11-L0-040S fabrikatzaileak: Grayhill, Inc. deskribapena: ROTARY ENCODER OPT 32PPR 4" CBL Stockean: Out stock</p> <p>RFQ</p>	 <p>62S11-H9-040S fabrikatzaileak: Grayhill, Inc. deskribapena: ROTARY ENCODER OPTICAL 32PPR Stockean: Out stock</p> <p>RFQ</p>
 <p>62S11-H9-020S fabrikatzaileak: Grayhill, Inc. deskribapena: ROTARY ENCODER OPTICAL 32PPR Stockean: Out stock</p> <p>RFQ</p>	 <p>62S11-H9-P fabrikatzaileak: Grayhill, Inc. deskribapena: ROTARY ENCODER OPTICAL 32PPR Stockean: Out stock</p> <p>RFQ</p>
 <p>62S11-H9-PH fabrikatzaileak: Grayhill, Inc. deskribapena: ROTARY ENCODER OPTICAL 32PPR Stockean: Out stock</p> <p>RFQ</p>	 <p>62S11-H9-025S fabrikatzaileak: Grayhill, Inc. deskribapena: ROTARY ENCODER OPTICAL 32PPR Stockean: Out stock</p> <p>RFQ</p>
 <p>62S11-H9-060C fabrikatzaileak: Grayhill, Inc. deskribapena: ROTARY ENCODER OPTICAL 32PPR Stockean: Out stock</p> <p>RFQ</p>	 <p>62S11-H9-040C fabrikatzaileak: Grayhill, Inc. deskribapena: ROTARY ENCODER OPTICAL 32PPR Stockean: Out stock</p> <p>RFQ</p>