





Coto Technology

9007-24-11

Zenbakiaren zenbakia:
 Fabrikatzaileak / Marka:
 Produktuaren Deskribapena
 Fitxak:
 RoHS egoera
 Ontziatik aurrera
 Bidalketa Bidea

9007-24-11
 Coto Technology
 RELAY REED SPST 500MA 24V
 9007-24-11.pdf
 Lead free / RoHS betez
 Hong Kong
 DHL/Fedex/TNT/UPS/EMS

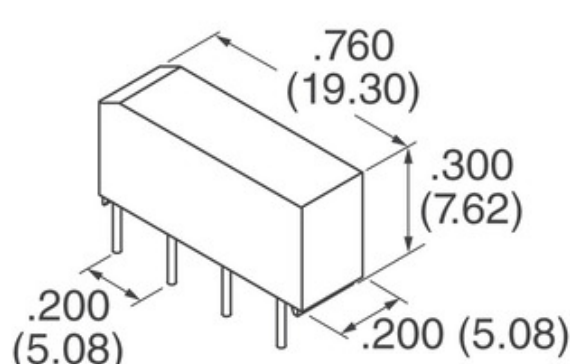

AURREKONTUEN ESKAERA

Irudia ordezkaritza izan daiteke. Ikusi produktuaren zehetasunetarako zehaztapenak.











9007-24-11ren zehaztapenak

| | |
|---|--|
| ZENBAKIAREN ZENBAKIA | 9007-24-11 |
| FABRIKATZAILEA | Coto Technology |
| DESKRIBAPENA | RELAY REED SPST 500MA 24V |
| LEAD FREE STATUS / ROHS EGOERA | Lead free / RoHS betez |
| DATUEN FITXA |  9007-24-11.pdf |
| AKTIBATU TENTSIOA (GEHIENEZ) | 18 VDC |
| AKTIBATU TENTSIOA (GUTXIENEZ) | 2 VDC |
| AMAIERA ESTILOA | PC Pin |
| TENTSIO ALDATZEA | 200VAC, 200VDC - Max |
| SERIES | 9000, Spartan |
| ASKATU ORDUA | 0.2ms |
| PACKAGING | Tube |
| TENPERATURA OPERATIBOA | -20°C ~ 85°C |
| DENBORA ERAGILEA | 0.5ms |
| MUNTAKETA MOTA | Through Hole |
| HEZETASUNAREN SENTIKORTASUN MAILA (MSL) | 1 (Unlimited) |
| FABRIKATZAILEAREN LEAD TIME ESTANDARRA | 30 Weeks |
| LEAD FREE STATUS / ROHS EGOERA | Lead free / RoHS Compliant |
| EZAUGARRIAK | Diode, Magnetic Shield |
| KONTAKTUEN BALORAZIOA (ORAINGO) | 500mA |
| HARREMANETARAKO MATERIALA | - |
| HARREMANETARAKO FORMULARIOA | SPST-NO (1 Form A) |
| BOBINA TENTSIOA | 24VDC |
| BOBINA MOTA | Non Latching |
| BOBINA ERRESISTENTZIA | 2 kOhms |
| COIL POWER | - |
| BOBINA KORRONTEA | 12.0mA |

Erlazionatutako etiketak

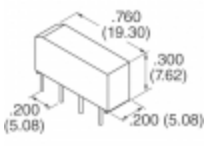
| | | |
|----------------------------|------------------------------|----------------------------------|
| Coto Technology 9007-24-11 | 9007-24-11 banatzailea | 9007-24-11 hornitzailea |
| 9007-24-11 prezioa | 9007-24-11 Irudiak | 9007-24-11 irudia |
| 9007-24-11 PDF Fitxa | 9007-24-11 Deskargatu Fitxa | 9007-24-11 Fitxa-orria |
| 9007-24-11 Stock | Erosi 9007-24-11 | Erosi Coto Technology 9007-24-11 |
| Coto Technology 9007-24-11 | Coto Technology hornitzailea | Coto Technology Banatzailea |
| Coto Technology 9007-24-11 | | |

Produktu erlazioatuak

| | |
|---|--|
|  <p>90075-0027 fabrikatzaileak: Affinity Medical Technologies - a Molex company deskribapena: CONN MOD PLUG 4P4C UNSHIELDED Stockean: Out stock</p> <p>RFQ</p> |  <p>9007-12-50 fabrikatzaileak: Coto Technology deskribapena: RELAY REED SPST 500MA 12V Stockean: Out stock</p> <p>RFQ</p> |
|  <p>9007210000 fabrikatzaileak: Weidmüller deskribapena: PLATE CUTTING KT45 Stockean: Out stock</p> <p>RFQ</p> |  <p>9007440000 fabrikatzaileak: Weidmüller deskribapena: SCREWDRIVER CORDLESS 9.41" Stockean: Out stock</p> <p>RFQ</p> |
|  <p>9007-24-01 fabrikatzaileak: Coto Technology deskribapena: RELAY REED SPST 500MA 24V Stockean: Out stock</p> <p>RFQ</p> |  <p>9007160000 fabrikatzaileak: Weidmüller deskribapena: HANDLES SET HT/PZ Stockean: Out stock</p> <p>RFQ</p> |
|  <p>9007-24-10 fabrikatzaileak: Coto Technology deskribapena: RELAY REED SPST 500MA 24V Stockean: 4 pcs</p> <p>RFQ</p> |  <p>9007-12-11 fabrikatzaileak: Coto Technology deskribapena: RELAY REED SPST 500MA 12V Stockean: Out stock</p> <p>RFQ</p> |
|  <p>9007480000 fabrikatzaileak: Weidmüller deskribapena: SCREWDRIVER CORDLESS W/CASE 1PC Stockean: Out stock</p> <p>RFQ</p> |  <p>90075-0031 fabrikatzaileak: Affinity Medical Technologies - a Molex company deskribapena: CONN MOD PLUG 6P6C UNSHIELDED Stockean: Out stock</p> <p>RFQ</p> |
|  <p>9007-24-00 fabrikatzaileak: Coto Technology deskribapena: RELAY REED SPST 500MA 24V Stockean: Out stock</p> <p>RFQ</p> |  <p>9007-12-40 fabrikatzaileak: Coto Technology deskribapena: RELAY REED SPST 500MA 12V Stockean: Out stock</p> <p>RFQ</p> |