





C&amp;K

## SDA07H0B

Zenbakiaren zenbakia:  
 Fabrikatzaileak / Marka:  
 Produktuaren Deskribapena  
 Fitxak:  
 RoHS egoera  
 Ontziatik aurrera  
 Bidalketa Bidea

SDA07H0B  
 C&K  
 SWITCH SLIDE DIP SPST 25MA 24V  
 SDA07H0B.pdf  
 Lead free / RoHS betez  
 Hong Kong  
 DHL/Fedex/TNT/UPS/EMS

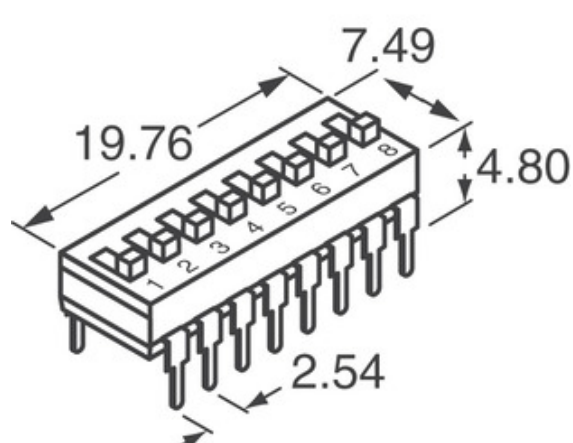
[AURREKONTUEN ESKAERA](#)

Irudia ordezkaritza izan daiteke. Ikusi produktuaren zehetasunetarako zehaztapenak.











## SDA07H0Bren zehaztapenak

ZENBAKIAREN ZENBAKIA	SDA07H0B
FABRIKATZAILEA	C&K
DESKRIBAPENA	SWITCH SLIDE DIP SPST 25MA 24V
LEAD FREE STATUS / ROHS EGOERA	Lead free / RoHS betez
DATUEN FITXA	 SDA07H0B.pdf
GARBI DAITEKEEN	Yes
TENTSIOAREN BALORAZIOA	24VDC
AMAIERA ESTILOA	PC Pin
SERIES	SDA
PITCH	0.100" (2.54mm), Full
PACKAGING	Tube
BESTE IZENAK	*SDA07H0B CKN6081
TENPERATURA OPERATIBOA	-40°C ~ 85°C
POSIZIO KOPURUA	7
MUNTAKETA MOTA	Through Hole
HEZETASUNAREN SENTIKORTASUN MAILA (MSL)	1 (Unlimited)
BIZITZA MEKANIKOA	1,000 Cycles
FABRIKATZAILEAREN LEAD TIME ESTANDARRA	16 Weeks
LUZERA	0.778" (19.76mm)
LEAD FREE STATUS / ROHS EGOERA	Lead free / RoHS Compliant
KONTSEILUKO GOIAN	0.183" (4.65mm)
EZAUGARRIAK	Tape Seal
BIZITZA ELEKTRIKOA	1,000 Cycles
DESKRIBAPEN ZEHATZA	Dip Switch SPST 7 Position Through Hole Slide (Standard) Actuator 25mA 24VDC
UNEKO BALORAZIOA	25mA
HARREMANETARAKO MATERIALA	Beryllium Copper
KONTAKTUA AMAITU	Gold
ZIRKUITUA	SPST
GORPUTZAREN MATERIALA	Polyphenylene Sulfide (PPS)
EKINTZA MOTA	Slide (Standard)
EKINTZA MAILA	Flush, Recessed

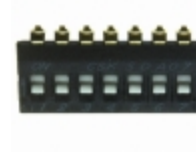
## Erlazionatutako etiketak

C&K SDA07H0B	SDA07H0B banatzailea	SDA07H0B hornitzailea
SDA07H0B prezioa	SDA07H0B Irudiak	SDA07H0B irudia
SDA07H0B PDF Fitxa	SDA07H0B Deskargatu Fitxa	SDA07H0B Fitxa-orria
SDA07H0B Stock	Erosi SDA07H0B	Erosi C&K SDA07H0B
C&K SDA07H0B	C&K hornitzailea	C&K Banatzailea
C&K SDA07H0B	C&K Components SDA07H0B	

## Produktu erlazionatuak

 <p><b>SDA06H1BD</b>          fabrikatzaileak: C&amp;K          deskribapena: SWITCH SLIDE DIP SPST 25MA 24V          Stockean: Out stock  <a href="#">RFQ</a></p>	 <p><b>SDA06H1KD</b>          fabrikatzaileak: C&amp;K          deskribapena: SWITCH SLIDE DIP SPST 25MA 24V          Stockean: Out stock  <a href="#">RFQ</a></p>
 <p><b>SDA07H0K</b>          fabrikatzaileak: C&amp;K          deskribapena: SWITCH SLIDE DIP SPST 25MA 24V          Stockean: Out stock  <a href="#">RFQ</a></p>	 <p><b>SDA06H0SKD</b>          fabrikatzaileak: C&amp;K          deskribapena: SWITCH SLIDE DIP SPST 25MA 24V          Stockean: Out stock  <a href="#">RFQ</a></p>
 <p><b>SDA07H0SBR</b>          fabrikatzaileak: C&amp;K          deskribapena: SWITCH SLIDE DIP SPST 25MA 24V          Stockean: Out stock  <a href="#">RFQ</a></p>	 <p><b>SDA07H0SBD</b>          fabrikatzaileak: C&amp;K          deskribapena: SWITCH SLIDE DIP SPST 25MA 24V          Stockean: 180 pcs  <a href="#">RFQ</a></p>
 <p><b>SDA06H0SK</b>          fabrikatzaileak: C&amp;K          deskribapena: SWITCH SLIDE DIP SPST 25MA 24V          Stockean: Out stock  <a href="#">RFQ</a></p>	 <p><b>SDA07H0SB</b>          fabrikatzaileak: C&amp;K          deskribapena: SWITCH SLIDE DIP SPST 25MA 24V          Stockean: 367 pcs  <a href="#">RFQ</a></p>
 <p><b>SDA07H0KD</b>          fabrikatzaileak: C&amp;K          deskribapena: SWITCH SLIDE DIP SPST 25MA 24V          Stockean: Out stock  <a href="#">RFQ</a></p>	 <p><b>SDA06H1SBD</b>          fabrikatzaileak: C&amp;K          deskribapena: SWITCH SLIDE DIP SPST 25MA 24V          Stockean: 904 pcs  <a href="#">RFQ</a></p>
 <p><b>SDA07H0BD</b>          fabrikatzaileak: C&amp;K          deskribapena: SWITCH SLIDE DIP SPST 25MA 24V          Stockean: 143 pcs  <a href="#">RFQ</a></p>	 <p><b>SDA06H1SKD</b>          fabrikatzaileak: C&amp;K          deskribapena: SWITCH SLIDE DIP SPST 25MA 24V          Stockean: Out stock  <a href="#">RFQ</a></p>