





Coto Technology

9002-05-02

Zenbakiaren zenbakia:
 Fabrikatzaileak / Marka:
 Produktuaren Deskribapena
 Fitxak:
 RoHS egoera
 Ontziatik aurrera
 Bidalketa Bidea

9002-05-02
 Coto Technology
 RELAY RF SPST 500MA 5V
 9002-05-02.pdf
 Lead free / RoHS betez
 Hong Kong
 DHL/Fedex/TNT/UPS/EMS

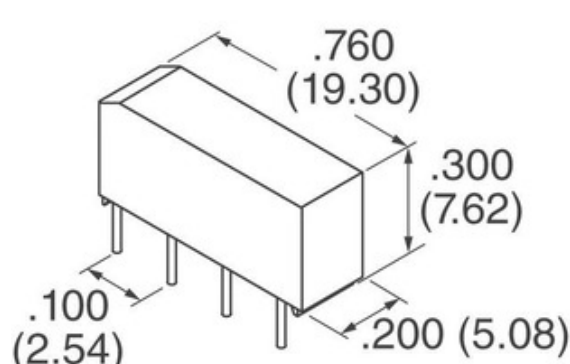

AURREKONTUEN ESKAERA

Irudia ordezkari izan daiteke. Ikusi produktuaren xehetasunetarako zehaztapenak.







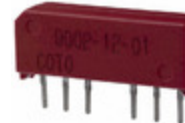

9002-05-02ren zehaztapenak

ZENBAKIAREN ZENBAKIA	9002-05-02
FABRIKATZAILEA	Coto Technology
DESKRIBAPENA	RELAY RF SPST 500MA 5V
LEAD FREE STATUS / ROHS EGOERA	Lead free / RoHS betez
DATUEN FITXA	 9002-05-02.pdf
AKTIBATU TENTSIOA (GEHIENEZ)	3.75 VDC
AKTIBATU TENTSIOA (GUTXIENEZ)	0.4 VDC
AMAIERA ESTILOA	PC Pin
TENTSIO ALDATZEA	200VAC, 200VDC - Max
SERIES	9000
ASKATU ORDUA	0.1ms
PACKAGING	Tube
BESTE IZENAK	306-1441 9002-05-02-ND
TENPERATURA OPERATIBOA	-20°C ~ 85°C
DENBORA ERAGILEA	0.35ms
MUNTAKETA MOTA	Through Hole
HEZETASUNAREN SENTIKORTASUN MAILA (MSL)	1 (Unlimited)
LEAD FREE STATUS / ROHS EGOERA	Lead free / RoHS Compliant
EZAUGARRIAK	-
KONTAKTUEN BALORAZIOA (ORAINGO)	500mA
HARREMANETARAKO MATERIALA	-
HARREMANETARAKO FORMULARIOA	SPST-NC (1 Form B)
BOBINA TENTSIOA	5VDC
BOBINA MOTA	Non Latching
BOBINA ERRESISTENTZIA	350 Ohms
COIL POWER	-
BOBINA KORRONTEA	14.3mA

Erlazionatutako etiketak

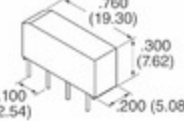
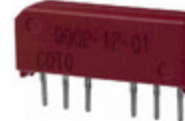
Coto Technology 9002-05-02	9002-05-02 banatzailea	9002-05-02 hornitzailea
9002-05-02 prezioa	9002-05-02 Irudiak	9002-05-02 irudia
9002-05-02 PDF Fitxa	9002-05-02 Deskargatu Fitxa	9002-05-02 Fitxa-orria
9002-05-02 Stock	Erosi 9002-05-02	Erosi Coto Technology 9002-05-02
Coto Technology 9002-05-02	Coto Technology hornitzailea	Coto Technology Banatzailea
Coto Technology 9002-05-02		

Produktu erlazioatuak

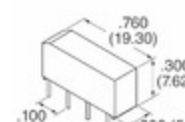
 <p>9002-05-11 fabrikatzaileak: Coto Technology deskribapena: RELAY RF SPST 500MA 5V Stockean: Out stock</p> <p>RFQ</p>	 <p>9002-05-00 fabrikatzaileak: Coto Technology deskribapena: RELAY RF SPST 500MA 5V Stockean: Out stock</p> <p>RFQ</p>
 <p>9001EN6 fabrikatzaileak: Honeywell Sensing and Productivity Solutions deskribapena: SEALED AERO SWITCH Stockean: Out stock</p> <p>RFQ</p>	 <p>9002-12-00 fabrikatzaileak: Coto Technology deskribapena: RELAY RF SPST 500MA 12V Stockean: Out stock</p> <p>RFQ</p>
 <p>9002-05-10 fabrikatzaileak: Coto Technology deskribapena: RELAY RF SPST 500MA 5V Stockean: Out stock</p> <p>RFQ</p>	 <p>9001EN36 fabrikatzaileak: Honeywell Sensing and Productivity Solutions deskribapena: SEALED AERO SWITCH Stockean: Out stock</p> <p>RFQ</p>
 <p>9002-12-10 fabrikatzaileak: Coto Technology deskribapena: RELAY RF SPST 500MA 12V Stockean: Out stock</p> <p>RFQ</p>	 <p>9002-05-01 fabrikatzaileak: Coto Technology deskribapena: RELAY RF SPST 500MA 5V Stockean: Out stock</p> <p>RFQ</p>
 <p>9002 fabrikatzaileak: Keystone Electronics Corp. deskribapena: JACK PIN SHROUDED MALE INS BLACK Stockean: Out stock</p> <p>RFQ</p>	 <p>9002-12-01 fabrikatzaileak: Coto Technology deskribapena: RELAY RF SPST 500MA 12V Stockean: Out stock</p> <p>RFQ</p>
 <p>9001EN37B fabrikatzaileak: Honeywell Sensing and Productivity Solutions deskribapena: SEALED AERO SWITCH Stockean: Out stock</p> <p>RFQ</p>	 <p>9002-12-11 fabrikatzaileak: Coto Technology deskribapena: RELAY RF SPST 500MA 12V Stockean: Out stock</p> <p>RFQ</p>