



Grayhill, Inc.

62S11-N0-040C

Zenbakiaren zenbakia: 62S11-N0-040C

Fabrikatzaileak / Marka: Grayhill, Inc.

Produktuaren Deskribapena: ROTARY ENCODER OPT 32PPR 4" CBL

Fitxak: [PDF 62S11-N0-040C.pdf](#)RoHS egoera:  Lead free / RoHS betez

Ontziatik aurrera: Hong Kong

Bidalketa Bidea: DHL/Fedex/TNT/UPS/EMS

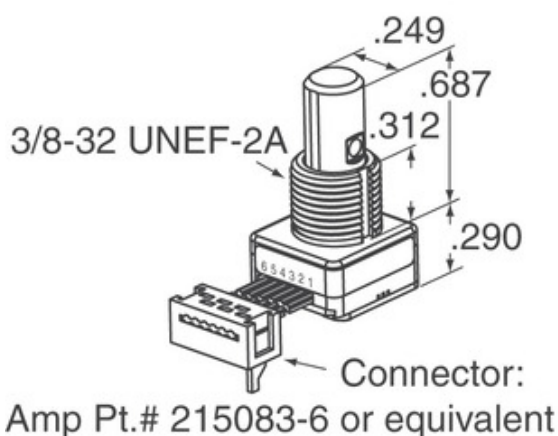
**AURREKONTUEN ESKAERA**

Irudia ordezkari izan daiteke. Ikusi produktuaren xehetasunetarako zehaztapenak.





62S11-N0-040Cren zehaztapenak

ZENBAKIAREN ZENBAKIA	62S11-N0-040C
FABRIKATZAILEA	Grayhill, Inc.
DESKRIBAPENA	ROTARY ENCODER OPT 32PPR 4" CBL
LEAD FREE STATUS / ROHS EGOERA	Lead free / RoHS betez
DATUEN FITXA	PDF 62S11-N0-040C.pdf
TENTSIOA - HORNIDURA	5V
AMAIERA ESTILOA	Cable with Connector
SERIES	62S
BIRAKETA-BIZITZA (ZIKLOAK)	1M
IRAULTZA BAKOITZEKO LEKALEAK	32
IRTEERAKO MOTA	Quadrature (Incremental)
BESTE IZENAK	Q4155128
ORIENTAZIO	Vertical
MUNTAKETA MOTA	Panel Mount
HEZETASUNAREN SENTIKORTASUN MAILA (MSL)	1 (Unlimited)
FABRIKATZAILEAREN LEAD TIME ESTANDARRA	8 Weeks
LEAD FREE STATUS / ROHS EGOERA	Lead free / RoHS Compliant
KODETZAILE MOTA	Optical
DETENT	No
ALDATU ZEN	No
EKINTZA MOTA	1/4" Dia Flatted End

Erlazionatutako etiketak

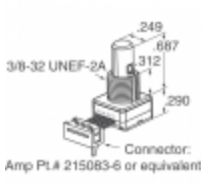
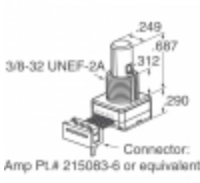
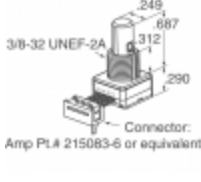
Grayhill, Inc. 62S11-N0-040C	62S11-N0-040C banatzailea	62S11-N0-040C hornitzailea
62S11-N0-040C prezioa	62S11-N0-040C Irudiak	62S11-N0-040C irudia
62S11-N0-040C PDF Fitxa	62S11-N0-040C Deskargatu Fitxa	62S11-N0-040C Fitxa-orria
62S11-N0-040C Stock	Erosi 62S11-N0-040C	Erosi Grayhill, Inc. 62S11-N0-040C
Grayhill, Inc. 62S11-N0-040C	Grayhill, Inc. hornitzailea	Grayhill, Inc. Banatzailea
Grayhill, Inc. 62S11-N0-040C	Grayhill Inc. 62S11-N0-040C	

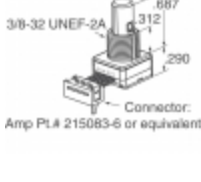
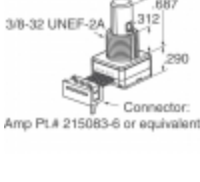
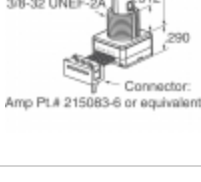
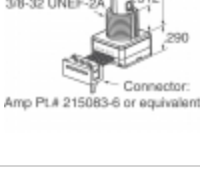
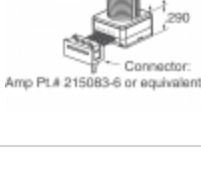
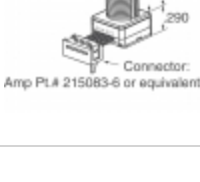
Produktu erlazioatuak

 <p>62S11-N0-040S fabrikatzaileak: Grayhill, Inc. deskribapena: ROTARY ENCODER OPTICAL 32PPR Stockean: Out stock</p> <p>RFQ</p>	 <p>62S11-N0-020SH fabrikatzaileak: Grayhill, Inc. deskribapena: ROTARY ENCODER OPTICAL 32PPR Stockean: Out stock</p> <p>RFQ</p>
 <p>62S11-N0-050C fabrikatzaileak: Grayhill, Inc. deskribapena: ROTARY ENCODER OPTICAL 32PPR Stockean: Out stock</p> <p>RFQ</p>	 <p>62S11-N0-040CH fabrikatzaileak: Grayhill, Inc. deskribapena: ROTARY ENCODER OPT 32PPR 4" CBL Stockean: Out stock</p> <p>RFQ</p>
 <p>62S11-N0-020C fabrikatzaileak: Grayhill, Inc. deskribapena: ROTARY ENCODER OPTICAL 32PPR Stockean: Out stock</p> <p>RFQ</p>	 <p>62S11-N0-020S fabrikatzaileak: Grayhill, Inc. deskribapena: ROTARY ENCODER OPTICAL 32PPR Stockean: Out stock</p> <p>RFQ</p>
 <p>62S11-N0-P fabrikatzaileak: Grayhill, Inc. deskribapena: ROTARY ENCODER OPTICAL 32PPR Stockean: Out stock</p> <p>RFQ</p>	 <p>62S11-N0-020CH fabrikatzaileak: Grayhill, Inc. deskribapena: ROTARY ENCODER OPTICAL 32PPR Stockean: Out stock</p> <p>RFQ</p>
 <p>62S11-M9-PH fabrikatzaileak: Grayhill, Inc. deskribapena: ROTARY ENCODER OPTICAL 32PPR Stockean: Out stock</p> <p>RFQ</p>	 <p>62S11-M9-P fabrikatzaileak: Grayhill, Inc. deskribapena: ROTARY ENCODER OPTICAL 32PPR Stockean: Out stock</p> <p>RFQ</p>
 <p>62S11-N0-PHV fabrikatzaileak: Grayhill, Inc. deskribapena: ROTARY ENCODER OPTICAL 32PPR Stockean: Out stock</p> <p>RFQ</p>	 <p>62S11-N0-PH fabrikatzaileak: Grayhill, Inc. deskribapena: ROTARY ENCODER OPTICAL 32PPR Stockean: Out stock</p> <p>RFQ</p>