



**HumRC™ Series Remote  
Control and Sensor Transceiver  
Data Guide**

**Wireless made simple®**

**Warning:** Some customers may want Linx radio frequency (“RF”) products to control machinery or devices remotely, including machinery or devices that can cause death, bodily injuries, and/or property damage if improperly or inadvertently triggered, particularly in industrial settings or other applications implicating life-safety concerns (“Life and Property Safety Situations”).

**NO OEM LINX REMOTE CONTROL OR FUNCTION MODULE SHOULD EVER BE USED IN LIFE AND PROPERTY SAFETY SITUATIONS.** No OEM Linx Remote Control or Function Module should be modified for Life and Property Safety Situations. Such modification cannot provide sufficient safety and will void the product’s regulatory certification and warranty.

Customers may use our (non-Function) Modules, Antenna and Connectors as part of other systems in Life Safety Situations, but only with necessary and industry appropriate redundancies and in compliance with applicable safety standards, including without limitation, ANSI and NFPA standards. It is solely the responsibility of any Linx customer who uses one or more of these products to incorporate appropriate redundancies and safety standards for the Life and Property Safety Situation application.

**Do not use this or any Linx product to trigger an action directly from the data line or RSSI lines without a protocol or encoder/decoder to validate the data.** Without validation, any signal from another unrelated transmitter in the environment received by the module could inadvertently trigger the action.

**All RF products are susceptible to RF interference that can prevent communication.** RF products without frequency agility or hopping implemented are more subject to interference. This module does have a frequency hopping protocol built in, but the developer should still be aware of the risk of interference.

**Do not use any Linx product over the limits in this data guide.** Excessive voltage or extended operation at the maximum voltage could cause product failure. Exceeding the reflow temperature profile could cause product failure which is not immediately evident.

**Do not make any physical or electrical modifications to any Linx product.** This will void the warranty and regulatory and UL certifications and may cause product failure which is not immediately evident.

# Table of Contents

1	<a href="#">Description</a>
1	<a href="#">Features</a>
2	<a href="#">Ordering Information</a>
2	<a href="#">Absolute Maximum Ratings</a>
3	<a href="#">Electrical Specifications</a>
6	<a href="#">Typical Performance Graphs</a>
16	<a href="#">Pin Assignments</a>
16	<a href="#">Pin Descriptions</a>
18	<a href="#">Pre-Certified Module Pin Assignments</a>
19	<a href="#">Module Dimensions</a>
20	<a href="#">Theory of Operation</a>
21	<a href="#">Module Description</a>
22	<a href="#">Transceiver Operation</a>
23	<a href="#">Transmit Operation</a>
24	<a href="#">Receive Operation</a>
24	<a href="#">Acknowledgement</a>
25	<a href="#">Automatic Responses</a>
25	<a href="#">Permissions Mask</a>
26	<a href="#">The Pair Process</a>
27	<a href="#">Configuring the Status Lines</a>
27	<a href="#">External Amplifier Control</a>
28	<a href="#">Mode Indicator</a>
28	<a href="#">Reset to Factory Default</a>
29	<a href="#">Using the LVL_ADJ Line</a>
30	<a href="#">Receiver Duty Cycle</a>
32	<a href="#">Using the LATCH_EN Line</a>
32	<a href="#">Using the Low Power Features</a>
33	<a href="#">Triggered Transmissions</a>
34	<a href="#">Frequency Hopping</a>

36	<a href="#">The Command Data Interface</a>
38	<a href="#">Serial Setup Configuration for Stand-alone Operation</a>
40	<a href="#">Basic Hardware Operation</a>
42	<a href="#">Typical Applications</a>
44	<a href="#">Usage Guidelines for FCC and IC Compliance</a>
44	<a href="#">Additional Testing Requirements</a>
45	<a href="#">Information to the user</a>
46	<a href="#">Product Labeling</a>
46	<a href="#">FCC RF Exposure Statement</a>
46	<a href="#">Antenna Selection</a>
48	<a href="#">Castellation Version Reference Design</a>
50	<a href="#">Power Supply Requirements</a>
50	<a href="#">Antenna Considerations</a>
51	<a href="#">Interference Considerations</a>
52	<a href="#">Pad Layout</a>
53	<a href="#">Microstrip Details</a>
54	<a href="#">Board Layout Guidelines</a>
55	<a href="#">Helpful Application Notes from Linx</a>
56	<a href="#">Production Guidelines</a>
56	<a href="#">Hand Assembly</a>
56	<a href="#">Automated Assembly</a>
58	<a href="#">General Antenna Rules</a>
60	<a href="#">Common Antenna Styles</a>
62	<a href="#">Regulatory Considerations</a>

## HumRC™ Series Remote Control and Sensor Transceiver

# Data Guide



### Description

The HumRC™ Series transceiver is designed for reliable bi-directional remote control applications. It consists of a highly optimized Frequency Hopping Spread Spectrum (FHSS) RF transceiver and integrated remote control transcoder. The FHSS system allows higher RF output power and, therefore, longer range than narrowband radios. It also provides much more noise immunity than narrowband radios, making the module suitable for use in noisy environments.

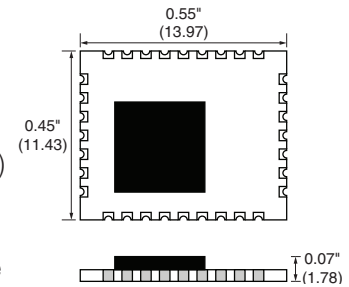

Figure 1: Package Dimensions

Eight status lines can be set up in any combination of inputs and outputs for the transfer of button or contact states. A selectable acknowledgement indicates that the transmission was successfully received. Versions are available in the 902 to 928MHz and 2,400 to 2,483MHz frequency bands.

Primary settings are hardware-selectable, which eliminates the need for an external microcontroller or other digital interface. For advanced features, optional software configuration is provided by a UART interface; however, no programming is required for basic operation.

Housed in a compact reflow-compatible SMD package, the transceiver requires no external RF components except an antenna, which greatly simplifies integration and lowers assembly costs.

### Features

- Low power consumption
- 2<sup>32</sup> possible addresses
- 8 status lines
- Bi-directional remote control
- Analog voltage and sensor inputs
- Low power receive modes
- Selectable acknowledgements
- No external RF components required
- No programming/tuning required
- Serial interface for optional software operation/configuration
- Tiny PLCC-32 footprint

## Ordering Information

Ordering Information	
Part Number	Description
HUM-***-RC	HumRC™ Series Remote Control Transceiver
HUM-900-RC-UFL	HumRC™ Series Remote Control Transceiver, Certified, UFL Connector
HUM-900-RC-CAS	HumRC™ Series Remote Control Transceiver, Certified, Castellated Connection
EVM-***-RC	HumRC™ Series Carrier Board
EVM-900-RC-UFL	HumRC™ Series Carrier Board with Certified module, UFL Connector
EVM-900-RC-CAS	HumRC™ Series Carrier Board with Certified module, Castellated Connection
MDEV-***-RC	HumRC™ Series Master Development System
EVAL-***-RC	HumRC™ Series Basic Evaluation Kit

\*\*\* = Frequency; 900MHz, 2.4GHz

Figure 2: Ordering Information

## Absolute Maximum Ratings

Absolute Maximum Ratings				
Supply Voltage $V_{cc}$	-0.3	to	+3.9	VDC
Any Input or Output Pin	-0.3	to	$V_{cc} + 0.3$	VDC
RF Input		0		dBm
Operating Temperature	-40	to	+85	°C
Storage Temperature	-40	to	+85	°C

Exceeding any of the limits of this section may lead to permanent damage to the device. Furthermore, extended operation at these maximum ratings may reduce the life of this device.

Figure 3: Absolute Maximum Ratings

 **Warning:** This product incorporates numerous static-sensitive components. Always wear an ESD wrist strap and observe proper ESD handling procedures when working with this device. Failure to observe this precaution may result in module damage or failure.

## Electrical Specifications

HumRC™ Series Transceiver Specifications						
Parameter	Symbol	Min.	Typ.	Max.	Units	Notes
Power Supply						
Operating Voltage	$V_{cc}$	2.0		3.6	VDC	
Peak TX Supply Current	$I_{CCTX}$					
2.4GHz at +1dBm			28	29	mA	1,2
2.4GHz at -10dBm			19	20	mA	1,2
900MHz at +10dBm			36	38.5	mA	1,2
900MHz at 0dBm			22	24	mA	1,2
Average TX Supply Current						
2.4GHz at +1dBm			22	24	mA	1,2
900MHz at +10dBm			27.5	28.5	mA	1,2
RX Supply Current	$I_{OCRX}$		25.5	28	mA	1,2,3
Standby Current	$I_{SBY}$		0.5	1.4	μA	1,2
Power-Down Current	$I_{PDN}$		0.5	1.4	μA	1,2
RF Section						
Operating Frequency Band	$F_c$				MHz	
HUM-2.4-RC		2400		2483.5	MHz	
HUM-900-RC-ttt		902		928	MHz	
Number of Channels			25			
Channel Spacing						
HUM-2.4-RC			2.03		MHz	
HUM-900-RC-ttt			500		kHz	
Modulation Rate			38.4		kbps	
Receiver Section						
Spurious Emissions				-47	dBm	
Receiver Sensitivity						5
HUM-2.4-RC		-95	-99		dBm	5
HUM-900-RC-ttt		-94	-98		dBm	5
RSSI Dynamic Range			85		dB	
Transmitter Section						
Output Power	$P_o$					
HUM-2.4-RC		0	+1		dBm	6
HUM-900-RC-ttt		+8.5	+9.5		dBm	6
Harmonic Emissions	$P_H$		-41		dBc	6

HumRC™ Series Transceiver Specifications						
Parameter	Symbol	Min.	Typ.	Max.	Units	Notes
Output Power Control Range						
HUM-2.4-RC			56		dB	6
HUM-900-RC-ttt			40		dB	6
Antenna Port						
RF Impedance	$R_{IN}$		50		$\Omega$	4
Environmental						
Operating Temp. Range		-40		+85	$^{\circ}\text{C}$	4
Timing						
Module Turn-On Time						
Via $V_{CC}$				108	ms	4
Via POWER_DOWN				57	ms	4
Via Standby				57	ms	4
Serial Command Response						
Status, Volatile R/W			1	10	ms	8
Analog Input Reading			6	16	ms	8
NV Update, Factory Reset			80	110	ms	8
IU to RU Status High				50	ms	7
Channel Dwell Time				13.33	ms	
Interface Section						
Input						
Logic Low	$V_{IL}$			$0.3 \cdot V_{CC}$	VDC	
Logic High	$V_{IH}$	$0.7 \cdot V_{CC}$			VDC	
Output						
Logic Low, MODE_IND, CONFIRM	$V_{OLM}$			$0.3 \cdot V_{CC}$	VDC	1,9
Logic High, MODE_IND, CONFIRM	$V_{OHM}$	$0.7 \cdot V_{CC}$			VDC	1,9
Logic Low	$V_{OL}$			$0.3 \cdot V_{CC}$		1,10
Logic High	$V_{OH}$	$0.7 \cdot V_{CC}$				1,10

1. Measured at 3.3V $V_{CC}$	7. No RF interference
2. Measured at 25 $^{\circ}\text{C}$	8. From end of command to start of response
3. Input power < -60dBm	9. 60mA source/sink
4. Characterized but not tested	10. 6mA source/sink
5. PER = 5%	
6. Into a 50-ohm load	

Figure 4: Electrical Specifications

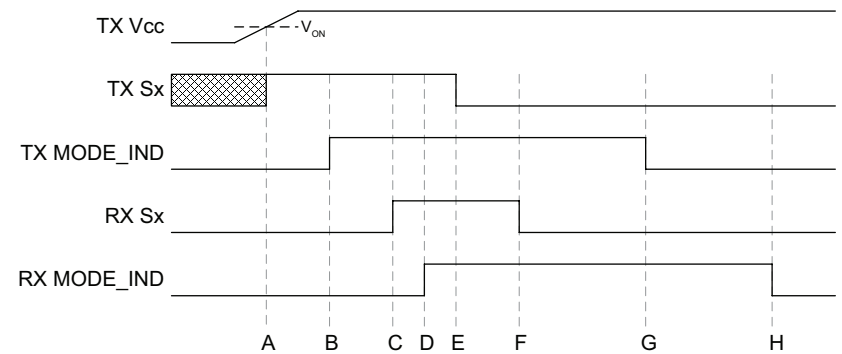

### HumRC™ Series Transceiver Timings

Item	Description	Minimum	Maximum
AB	TX Response from $V_{CC}$ or POWER_DOWN <sup>1,4</sup>		8ms
	TX Response from Status line while IU in idle <sup>2</sup>		12ms
	TX Response from Status line while IU / RU idle in RX <sup>3</sup>		1ms
BC	RX Initial Response	4ms	50ms
CD	Data Settle	4 $\mu\text{s}$	8 $\mu\text{s}$
EF	Data Update Delay During Active Session	5ms	25ms
EG	Shutdown Duration	25ms	342ms
GH	RX MODE_IND Drop	6ms	8ms

1. From module off to  $V_{CC}$  applied
2. The module is set as an IU only and is in idle pending status line activation
3. The module is set as an IU and RU and is idling in receive mode pending status line activation or receipt of a valid packet.
4. Maximum 80ms if  $V_{CC} < 2.6\text{V}$

Figure 5: HumRC™ Series Timings

## Typical Performance Graphs

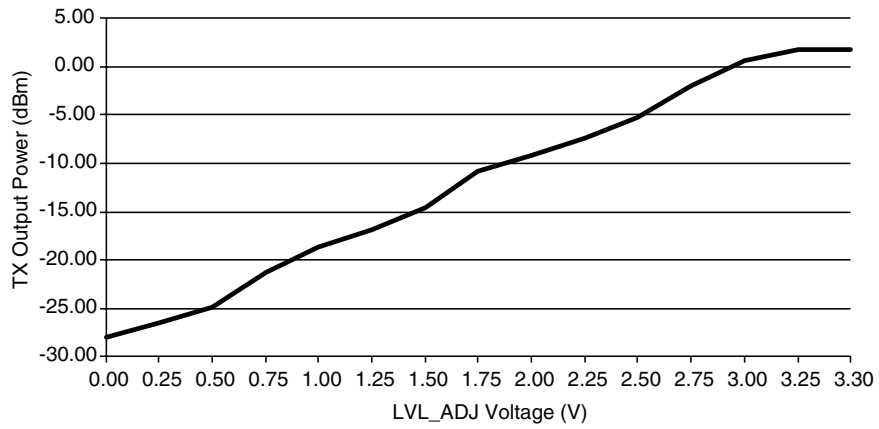

Figure 6: HumRC™ Series Transceiver Output Power vs. LVL\_ADJ Resistance - HUM-2.4-RC

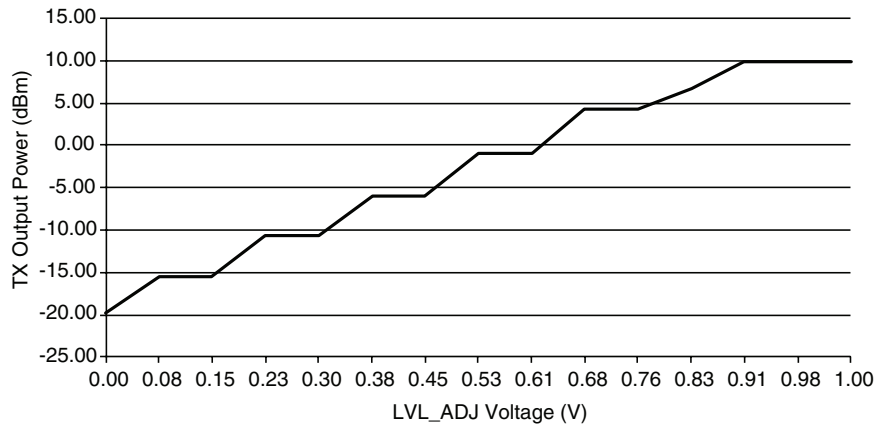

Figure 7: HumRC™ Series Transceiver Output Power vs. LVL\_ADJ Resistance - HUM-900-RC

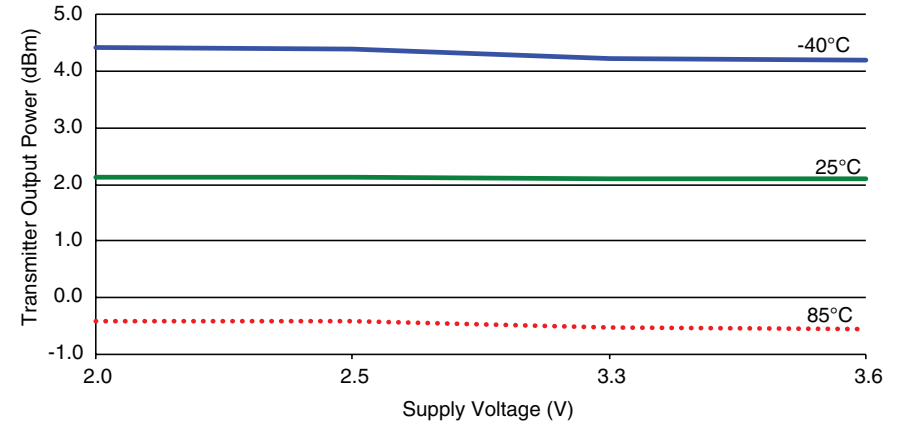

Figure 8: HumRC™ Series Transceiver Max Output Power vs. Supply Voltage - HUM-2.4-RC

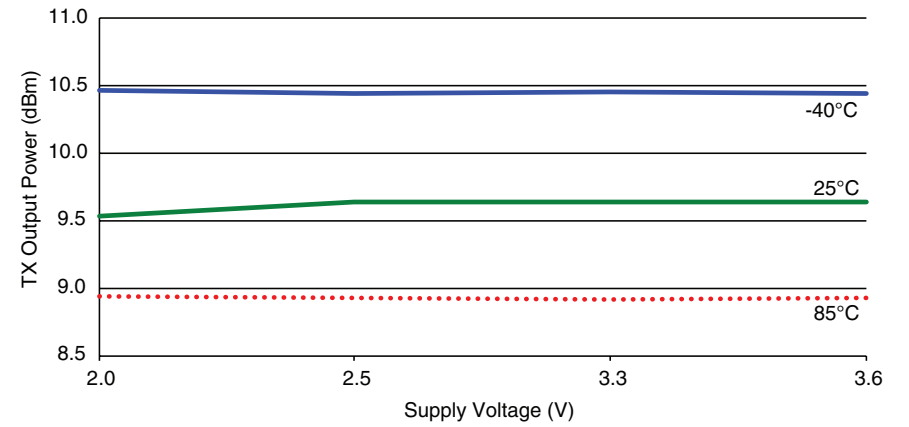

Figure 9: HumRC™ Series Transceiver Max Output Power vs. Supply Voltage - HUM-900-RC

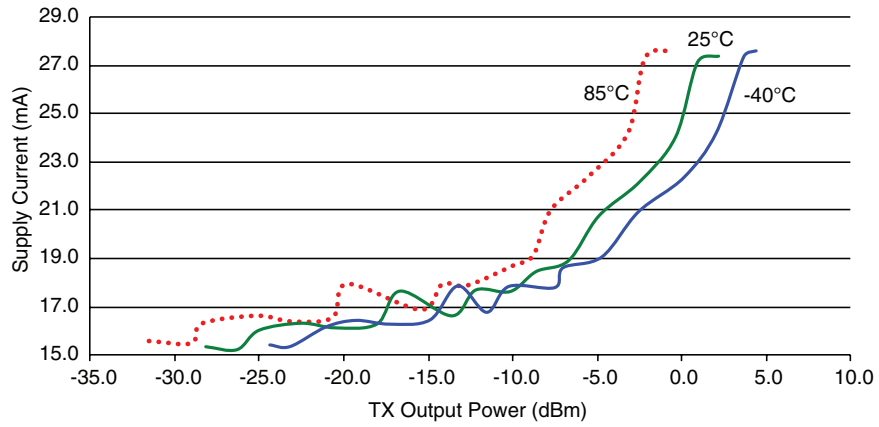

Figure 10: HumRC™ Series Transceiver Average Current vs. Transmitter Output Power at 2.5V - HUM-2.4-RC

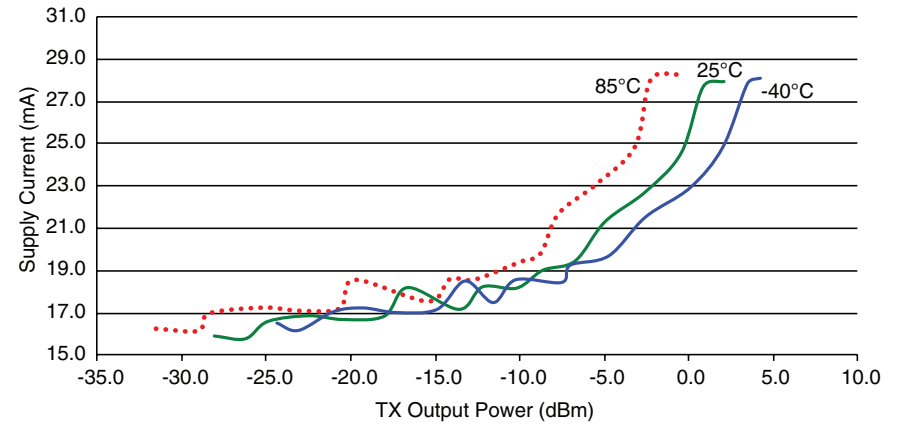

Figure 13: HumRC™ Series Transceiver Average TX Current vs. Transmitter Output Power at 3.3V - HUM-2.4-RC

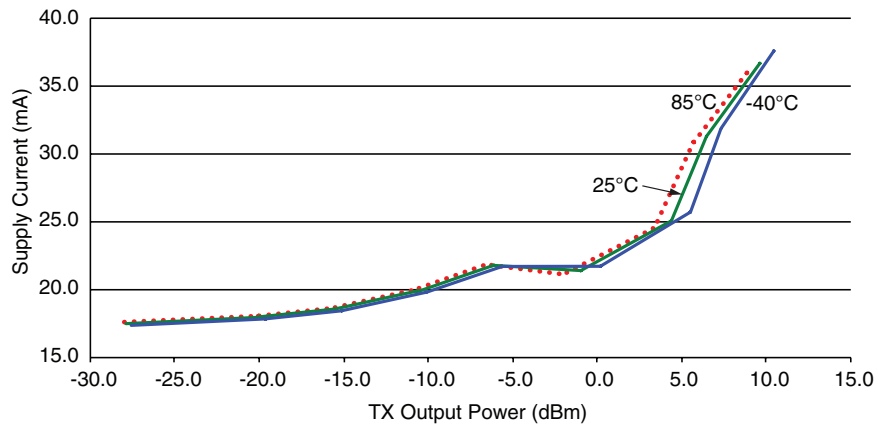

Figure 11: HumRC™ Series Transceiver Average Current vs. Transmitter Output Power at 2.5V - HUM-900-RC

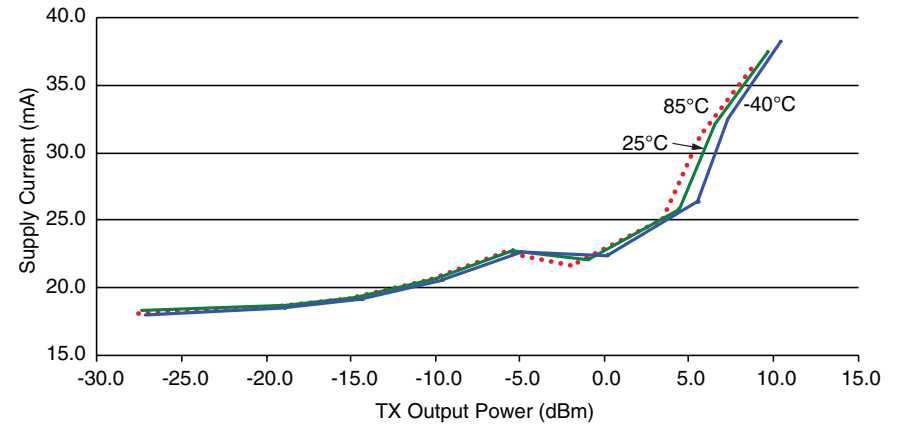

Figure 12: HumRC™ Series Transceiver Average TX Current vs. Transmitter Output Power at 3.3V - HUM-900-RC

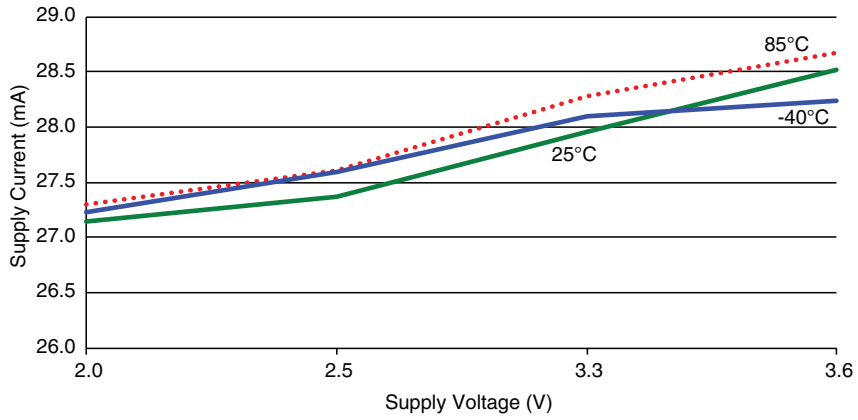

Figure 14: HumRC™ Series Transceiver TX Current vs. Supply Voltage at Max Power - HUM-2.4-RC

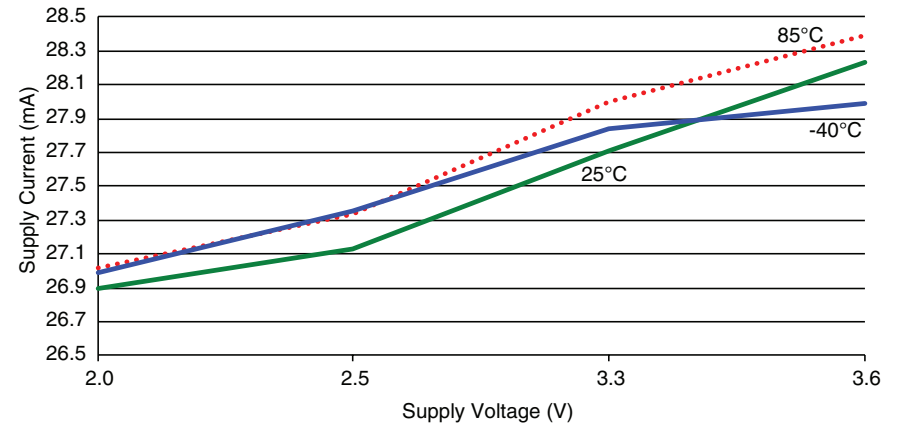

Figure 16: HumRC™ Series Transceiver TX Current vs. Supply Voltage at OdBm - HUM-2.4-RC

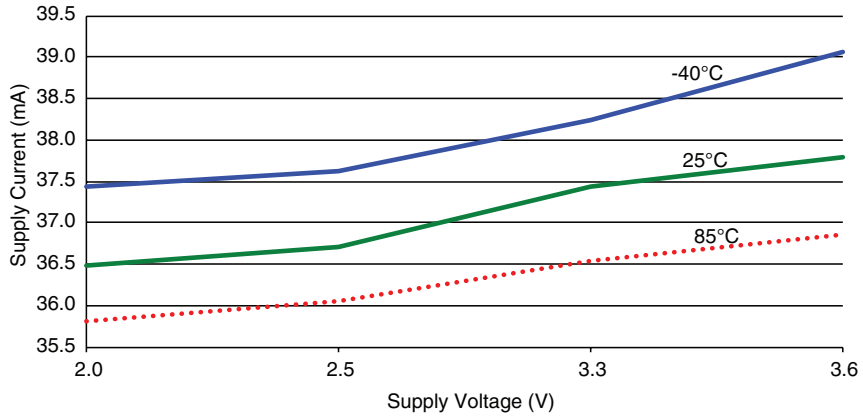

Figure 15: HumRC™ Series Transceiver TX Current vs. Supply Voltage at Max Power - HUM-900-RC

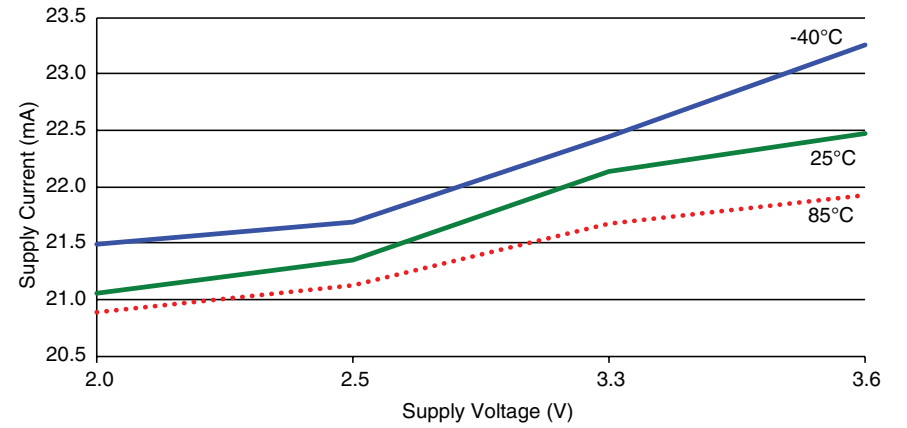

Figure 17: HumRC™ Series Transceiver TX Current vs. Supply Voltage at OdBm - HUM-900-RC



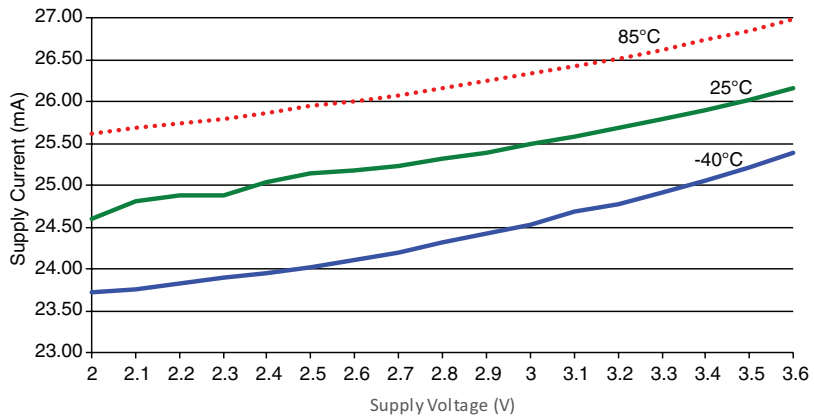

Figure 18: HumRC™ Series Transceiver RX Current Consumption vs. Supply Voltage - HUM-2.4-RC

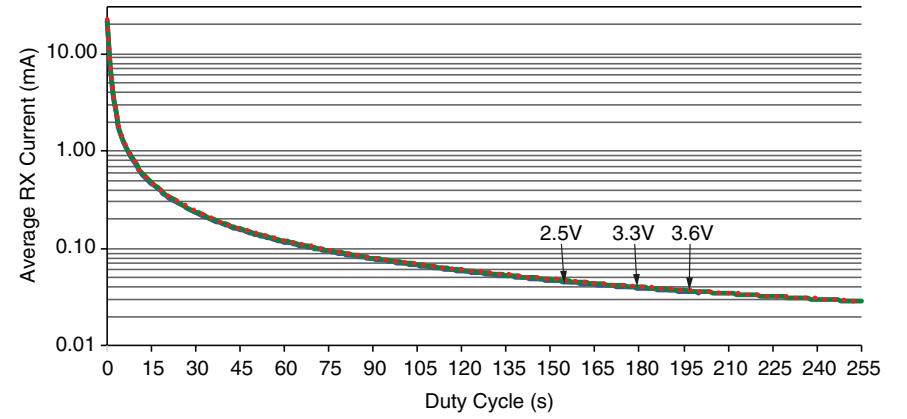

Figure 20: HumRC™ Series Transceiver Average RX Current Consumption vs. Duty Cycle - HUM-2.4-RC

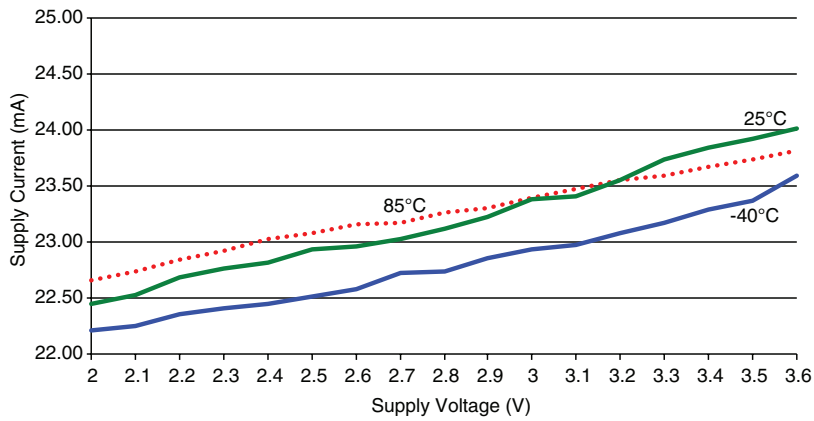

Figure 19: HumRC™ Series Transceiver RX Current Consumption vs. Supply Voltage - HUM-900-RC

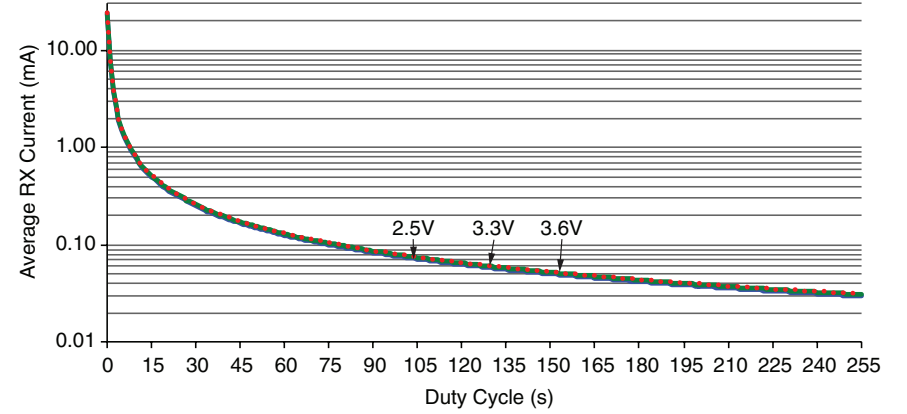

Figure 21: HumRC™ Series Transceiver Average RX Current Consumption vs. Duty Cycle - HUM-900-RC

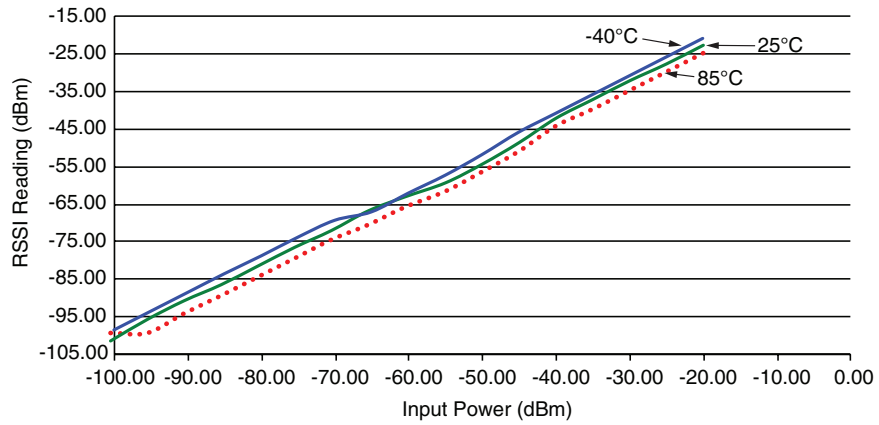

Figure 22: HumRC™ Series Transceiver RSSI Voltage vs. Input Power - HUM-2.4-RC

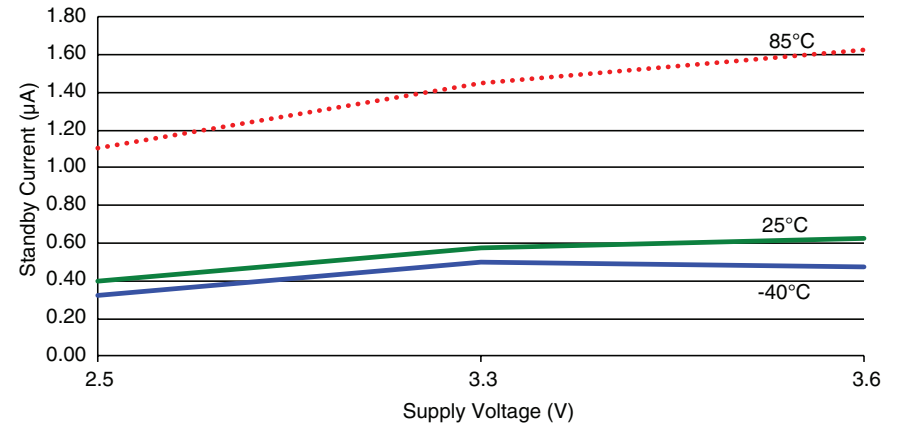

Figure 24: HumRC™ Series Transceiver Standby Current Consumption vs. Supply Voltage - HUM-2.4-RC

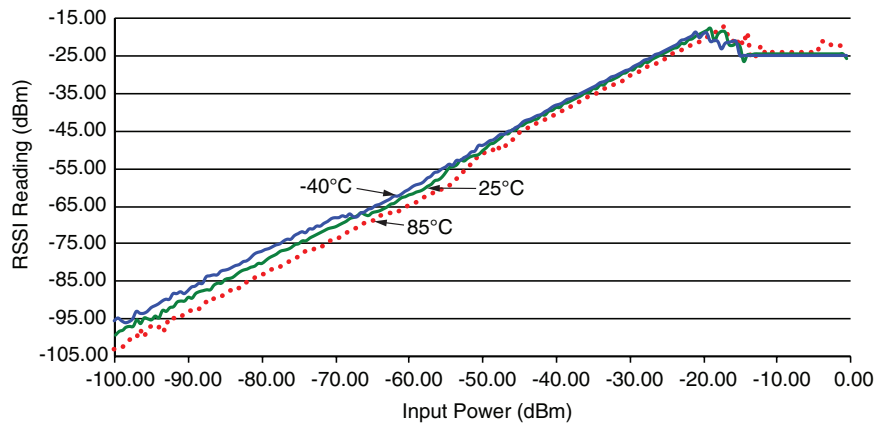

Figure 23: HumRC™ Series Transceiver RSSI Voltage vs. Input Power - HUM-900-RC

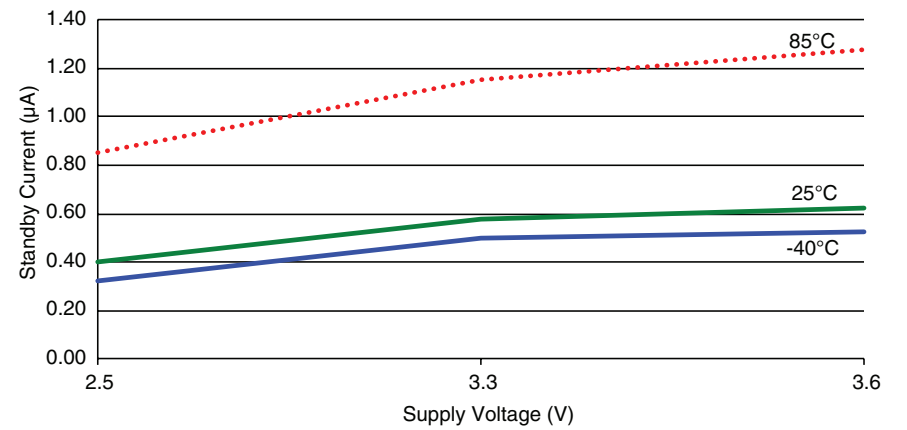

Figure 25: HumRC™ Series Transceiver Standby Current Consumption vs. Supply Voltage - HUM-900-RC

## Pin Assignments

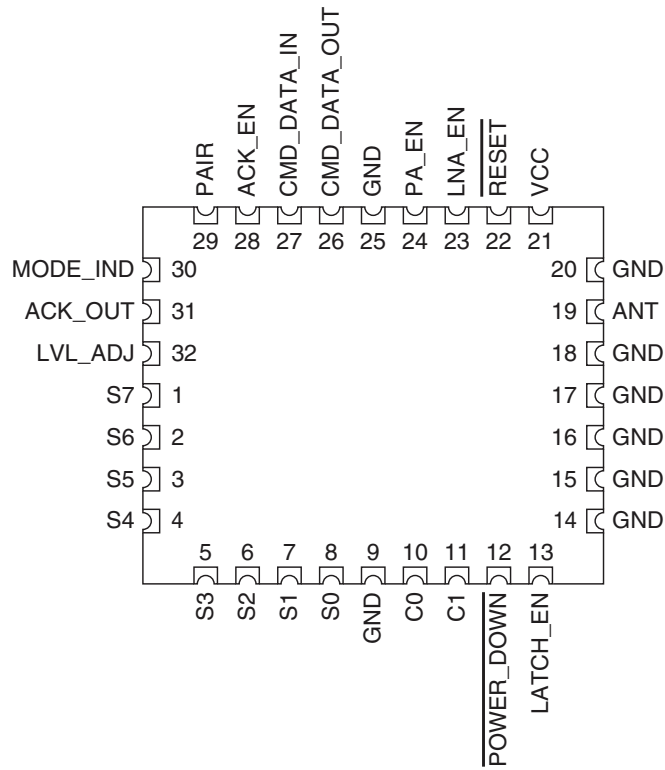

Figure 26: HumRC™ Series Transceiver Pin Assignments (Top View)

## Pin Descriptions

Pin Descriptions			
Pin Number	Name	I/O	Description
1, 2, 3, 4, 5, 6, 7, 8	S0-S7 <sup>1</sup>	I/O	Status Lines. Each line can be configured as either an input to register button or contact closures or as an output to control application circuitry.
9, 14, 15, 16, 17, 18, 20, 25	GND	—	Ground
10	C0	I	This line sets the input/output direction for status lines S0-S3. When low, the lines are outputs; when high they are inputs.
11	C1	I	This line sets the input/output direction for status lines S4-S7. When low, the lines are outputs; when high they are inputs.

Pin Descriptions			
Pin Number	Name	I/O	Description
12	$\overline{\text{POWER\_DOWN}}$	I	Power Down. Pulling this line low places the module into a low-power state. The module is not functional in this state. Pull high for normal operation. Do not leave floating.
13	LATCH_EN	I	If this line is high, then the status line outputs are latched (a received command to activate a status line toggles the output state). If this line is low, then the output lines are momentary (active for as long as a valid signal is received).
19	ANTENNA	—	50-ohm RF Antenna Port
21	VCC	—	Supply Voltage
22	$\overline{\text{RESET}}^2$	I	This line resets the module when pulled low. It should be pulled high for normal operation.
23	LNA_EN	O	Low Noise Amplifier Enable. This line is driven high when receiving. It is intended to activate an optional external LNA.
24	PA_EN	O	Power Amplifier Enable. This line is driven high when transmitting. It is intended to activate an optional external power amplifier.
26	CMD_DATA_OUT	O	Command Data Out. Output line for the serial interface commands
27	CMD_DATA_IN	I	Command Data In. Input line for the serial interface commands. If serial control is not used, this line should be tied to supply to minimize current consumption.
28	ACK_EN	I	Pull this line high to enable the module to send an acknowledgement message after a valid control message has been received.
29	PAIR <sup>1</sup>	I	A high on this line initiates the Pair process, which causes two units to accept each other's transmissions. It is also used with a special sequence to reset the module to factory default configuration.
30	MODE_IND	O	This line indicates module activity. It can source enough current to drive a small LED, causing it to flash. The duration of the flashes indicates the module's current state.
31	ACK_OUT	O	This line goes high when the module receives an acknowledgement message from another module after sending a control message.
32	LVL_ADJ	I	Level Adjust. The voltage on this line sets the transmitter output power level.

- These lines have an internal 20kΩ pull-down resistor
- These lines have an internal 10kΩ pull-up resistor

Figure 27: HumRC™ Series Transceiver Pin Descriptions

## Pre-Certified Module Pin Assignments

The pre-certified version of the module has mostly the same pin assignments as the standard version. The antenna connection is routed to either a castellation (-CAS) or a u.FL connector (-UFL), depending on the part number ordered.

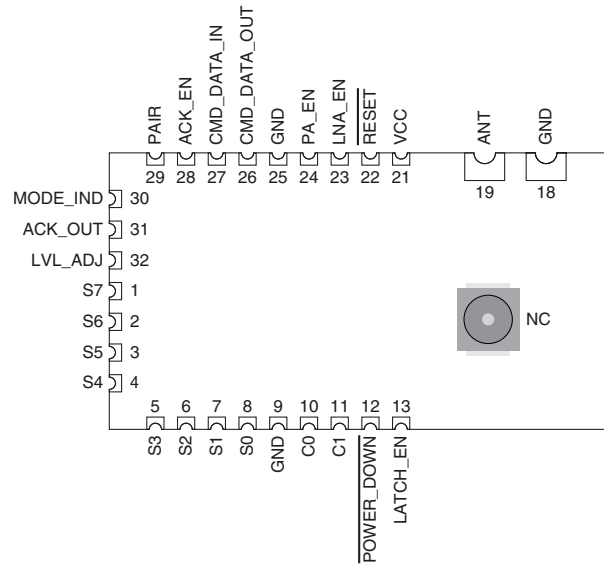

Figure 28: HumRC™ Series Transceiver Pre-certified Version Pin Assignments - Castellation Connection (Top View)

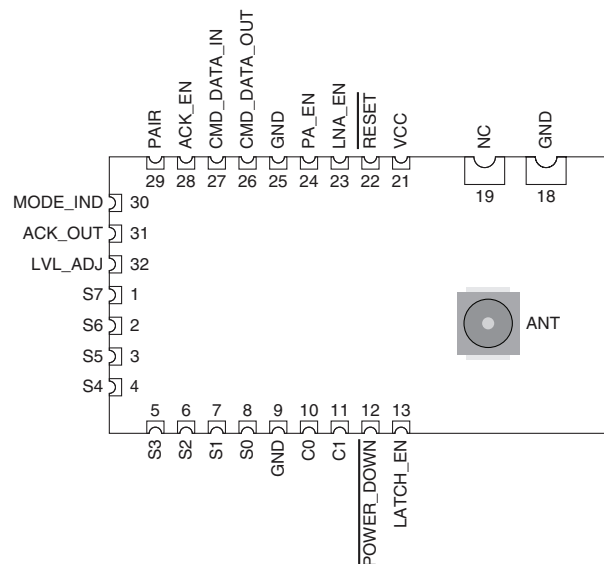

Figure 29: HumRC™ Series Transceiver Pre-certified Version Pin Assignments - UFL Connection (Top View)

## Module Dimensions

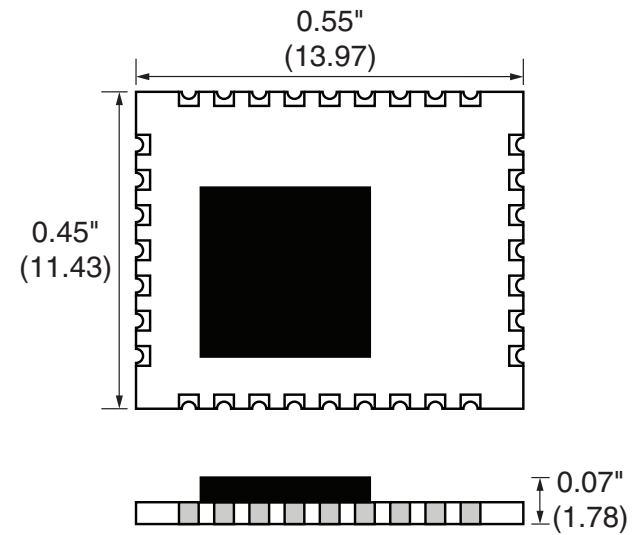

Figure 30: HumRC™ Series Transceiver Dimensions

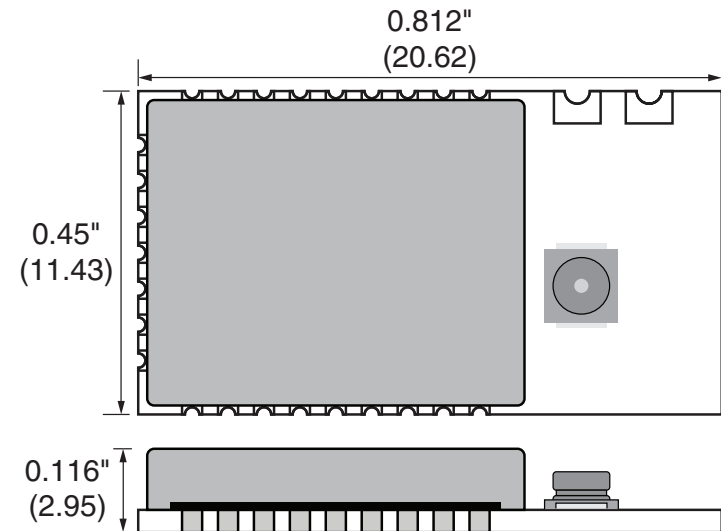

Figure 31: HumRC™ Series Transceiver Pre-certified Version Dimensions

## Theory of Operation

The HumRC™ Series transceiver is a low-cost, high-performance synthesized FSK transceiver. Figure 32 shows the module's block diagram.

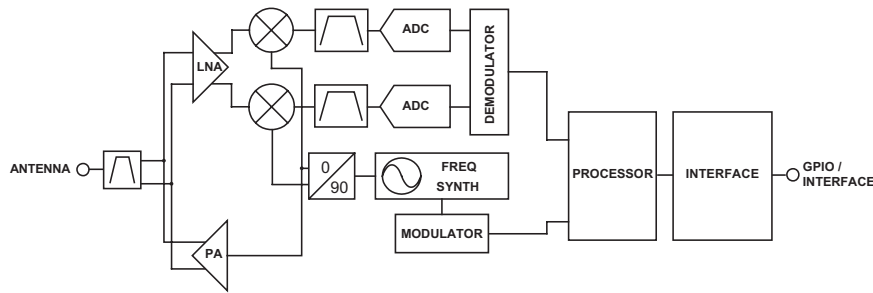

Figure 32: HumRC™ Series Transceiver RF Section Block Diagram

The HumRC™ Series transceiver operates in the 2400 to 2483MHz and 902 to 928MHz frequency bands. The transmitter output power is programmable. The range varies depending on the module's frequency band, antenna implementation and the local RF environment.

The RF carrier is generated directly by a frequency synthesizer that includes an on-chip VCO. The received RF signal is amplified by a low noise amplifier (LNA) and down-converted to I/Q quadrature signals. The I/Q signals are digitized by ADCs.

A low-power onboard communications processor performs the radio control and management functions including Automatic Gain Control (AGC), filtering, demodulation and packet synchronization. A control processor performs the higher level functions and controls the serial and hardware interfaces.

A crystal oscillator generates the reference frequency for the synthesizer and clocks for the ADCs and the processor.

## Module Description

The HumRC™ Series Remote Control module is a completely integrated RF transceiver and processor. It has two main modes of operation: hardware and software. Hardware operation is suitable for applications like keyfobs where no other processor, PC or interface is present. Software operation is more advanced and allows for more features and functionality. This guide focuses on hardware operation with some references to software operation. Please see Reference Guide RG-00104: the HumRC™ Series Command Data Interface for details on software operation.

Since this module can act as both transmitter and receiver, terminology and descriptions can get confusing. This guide uses the term Initiating Unit (IU) to describe a module that is transmitting commands. Responding Unit (RU) is used to describe a module that is receiving commands.

The module has 8 status lines numbered S0 through S7. These can be set as inputs for buttons or contacts or as outputs to drive application circuitry. When S0 is taken high on the IU, S0 goes high on the RU, and so forth. A line that is an input on one side needs to be set as an output on the other side.

Up to two of the lines S4, S5, S6 and S7 can be configured as analog inputs through the Command Data Interface. The voltage on an analog input can be transmitted upon activation of a digital input, or automatically sent in response to a query from an IU. These are ideal for sensor-based applications.

A trigger configuration provides self-timed periodic or limited-length transmission when an input goes high.

The transceiver uses a Frequency Hopping Spread Spectrum (FHSS) algorithm. This allows for higher output power and longer range than narrow-band systems while still maintaining regulatory compliance. All aspects of managing the FHSS operations are automatically handled by the module.

Each module is programmed with a unique 32-bit serial number at the factory. By default, this is used as the module's local address. The address can be changed through the Command Data Interface so that the module can be given a specific local address. The serial number cannot be changed.

## Transceiver Operation

The transceiver has two modes of operation: Initiating Unit (IU) that transmits control messages and Responding Unit (RU) that receives control messages. If all of the status lines are set as inputs, then the module is set as an IU only. The module stays in a low power sleep mode until a status line goes high, starting the Transmit Operation.

If all of the status lines are set as outputs, then the module is set as an RU only. It stays in Receive Operation looking for a valid transmission from a paired IU.

A module with both input and output status lines can operate as an IU and an RU. The module idles in Receive Operation until either a valid transmission is received or a status line input goes high, initiating the Transmit operation.

When an input goes high, the transceiver captures the logic state of each of the status lines. The line states are placed into a packet along with the local 32-bit address. The IU transmits the control packets as it hops among 25 RF channels.

An RU receives the packet and checks its Paired Module List to see if the IU has been paired with the module and is authorized to control it. If the IU's address is not in the table, then the RU ignores the transmission. If the address is in the table, then the RU calculates the channel hopping pattern from the IU's address and sets its status line outputs according to the received packet. It then hops along with the IU and updates the states of its outputs with every packet. Its outputs can be connected to external circuitry that activates when the lines go high.

The RU can also send an acknowledgement back to the IU. Using the serial interface the RU can include up to two bytes of custom data with the acknowledgement, such as sensor data or battery voltage levels. Using the hardware control, if ACK\_EN is high when a valid control packet is received, the RU sends back a simple acknowledgement (ACK). It can send an Acknowledge with Data (AWD) response when custom data is programmed into the module using a serial command.

## Transmit Operation

Transmit operation can be started by a status line input going high or a serial command.

Basic remote control applications use the status line activation. The module pulls the MODE\_IND line high and repeatedly transmits control messages containing the local address and the state of all status lines. Between transmissions the module listens for acknowledgement messages. If an Acknowledge (ACK) or Acknowledge with Data (AWD) message is received for the transmitted data, the ACK\_OUT line is asserted for 100ms. The ACK\_OUT timing restarts on each ACK or AWD packet that is received.

The transceiver sends control messages every 13.33ms as long as any of the status line inputs is high, updating the status line states with each packet. When all input lines are low, the module starts the shutoff sequence.

During the shutoff sequence, the transmitter sends at least one packet with all outputs off. It then continues to transmit data until the current channel hopping cycle is complete, resulting in balanced channel use. If an input line is asserted during the shutoff sequence, the transmitter cancels the shutoff and extends the transmission sequence.

The Transmit Control Data and Transmit IU Packet serial commands instruct the module to send control messages. The Transmit Control Data command is the serial command version of taking a status line input high. An external microcontroller can use this command to send a specified number of packets with a specified Status byte rather than taking status lines high.

The Transmit IU Packet command sends a packet that causes the RU to respond with a packet that can include the readings of its two analog inputs. This is good for reading remote sensors without having a microcontroller on the sensor unit. This reduces the cost and development time for remote sensor units.

The trigger configuration causes the module to send a pre-specified number of packets when a status line input goes high. This is good for remote monitoring and transmitting when an exception occurs without needing a microcontroller on the remote unit.

## Receive Operation

During Receive Operation, the module waits for a valid control message from an authorized (paired) transceiver. When a valid message is received, it locks onto the hopping pattern of the transmitter and asserts the MODE\_IND line. It compares the received status line states to the Permission Mask for the IU to see if the IU is authorized to activate the lines. The module sets all authorized outputs to match the received states. Only status line outputs are affected by received commands.

The RU then checks the state of the ACK\_EN line and transmits an acknowledgement packet if it is high. It looks for the next valid packet while maintaining the frequency hopping timing. As long as an RU is receiving valid commands from a paired IU, it will not respond to any other unit.

Once eight consecutive packets are missed, the RU is logically disconnected from the IU and waits for the next valid packet from any IU.

## Acknowledgement

A responding module is able to send an acknowledgement to the transmitting module. This allows the initiating module to know that the responding side received the command.

When the Responding Unit (RU) receives a valid Control Packet, it checks the state of the ACK\_EN line. If it is high the module sends an Acknowledgement Packet.

If the Initiating Unit (IU) receives an Acknowledgement Packet that has the same Address and Status Byte as in the Control Packet it originally sent, then it pulls the ACK\_OUT line high. A continuous stream of Control Packets that triggers a continuous stream of Acknowledgement Packets keeps the ACK\_OUT line high.

Connecting the ACK\_EN line to  $V_{CC}$  causes the RU to transmit Acknowledgement Packets as soon as it receives a valid Control Packet. Alternately this line can be controlled by an external circuit that raises the line when a specific action has taken place. This confirms to the IU that the action took place rather than just acknowledging receipt of the signal.

The module can also be configured to transmit an acknowledgement with two bytes of preset data. This feature is enabled using the Control Source parameter through the Command Data Interface (CDI). The IU outputs the

received bytes on its CDI for presentation to an external microcontroller or computer. The data can include sensor values, battery voltage levels or current status line states.

**Note:** Only one RU should be enabled to transmit an acknowledgement response for a given IU since multiple acknowledgements will interfere with each other.

## Automatic Responses

Two of the status lines can be configured as analog inputs to measure voltage levels. An IU can send a Request Sample command to an RU to respond with the analog measurements in the acknowledgement. This allows a master unit to remotely read a sensor device without having to place a microcontroller on the sensor.

The transceiver can be configured to respond with one or both analog values through the CDI. Please see Reference Guide RG-00104: the HumRC™ Series Command Data Interface for details on the CDI.

## Permissions Mask

The HumRC™ Series Transceiver has a Permissions Mask in the RU that is used to control which status lines an IU is authorized to control. With most systems, if a transmitter is associated with a receiver then it has full control over the receiver. With the Permissions Mask, a transmitter can be granted authority to control only certain receiver outputs. If an IU does not have the authority to activate a certain line, then the RU does not set it.

As an example, a factory worker can be given a fob that only opens the door to the factory floor while the CEO has a fob that can also open the executive offices. The hardware in the fobs is the same, but the permissions masks are set differently for each fob.

The Pair process always sets the Permission Mask to full access. The mask can be changed through the serial interface.

## The Pair Process

The Pair process enables two transceivers to communicate with each other. Each transceiver has a local 32-bit address that is transmitted with every packet. If the address in the received packet is not in the RU's Paired Module List, then the transceiver does not respond. Adding devices to the authorized list is accomplished through the Pair process or by a serial command. Each module can be paired with up to 40 other modules.

The Pair process is initiated by taking the PAIR line high or by sending the Pair Control serial command on both units to be associated. Activation on the PAIR line can either be a momentary pulse (less than two seconds) or a sustained high input, which can be used to extend the search and successful pairing display. With a momentary activation, the search is terminated after 30 seconds. If Pairing is initiated with a sustained high input, the search continues as long as the PAIR input is high.

When Pair is activated, the module displays the Pair Search sequence on the MODE\_IND line (Figure 34) and goes into a search mode where it looks for another module that is also in search mode. It alternates between transmit and receive, enabling one unit to find the other and respond.

Once bidirectional communication is established, the two units store each other's addresses in their Paired Module List with full Permissions Mask and display the Pair Found sequence on their MODE\_IND lines. The Pair Found sequence is displayed for at least 3 seconds. If PAIR is held high, the Pair Found display is shown for as long as PAIR is high. If a paired unit is already in the Paired Module List, then no additional entry is added though the existing entry's Permissions Mask may be modified.

When Pairing is initiated, the module pairs with the first unit it finds that is also in Pair Search. If multiple systems are being Paired in the same area, such as in a production environment, then steps should be taken to ensure that the correct units are paired with each other.

The Pair process can be cancelled by taking PAIR high a second time or by issuing the Pair Control command with Cancel Pairing option.

If the address table is full when the PAIR line is raised, the Pair Table Full sequence is displayed on the MODE\_IND line for 10 seconds and neither of the Pairing units stores an address. In this case, the module should either be reset to clear the address table or the serial interface can be used to remove addresses.

## Configuring the Status Lines

Each of the eight status lines can operate as a digital input or output. Configuring their direction can be done in two ways. Basic operation uses the C0 and C1 lines. When C0 is low, S0 through S3 are outputs; when C0 is high, S0 through S3 are inputs. Likewise when C1 is low, S4 through S7 are outputs; when C1 is high, S4 through S7 are inputs. This is shown in Figure 33.

Status Line Direction Configuration		
Line	0	1
C0	S0 through S3 are outputs	S0 through S3 are inputs
C1	S4 through S7 are outputs	S4 through S7 are inputs

Figure 33: MODE\_IND Timing

Advanced operation uses the CDI to set each line direction individually with the Status Line I/O Mask item. In addition, the Control Source Item is used to tell the module to use the serial command instead of the hardware line configuration.

Up to two of the status lines in the S4 through S7 group can be configured as analog inputs. An analog input line is used only for reading an input line voltage and converting it to a digital value (Analog to Digital Conversion, ADC). The analog input selection is primary, overriding digital input/output selection. An analog input reading can be transmitted to another module when functioning as either an IU or RU. The digitized reading must be read through a serial command at the receiving end. The analog setting is configured through the CDI using the Analog Input Select item.

Please see Reference Guide RG-00104: the HumRC™ Series Command Data Interface for details on the CDI.

## External Amplifier Control

The HumRC™ Series transceiver has two output lines that are designed to control external amplifiers. The PA\_EN line goes high when the module enters transmit mode. This can be used to activate an external power amplifier to boost the signal strength of the transmitter. The LNA\_EN line goes high when the module enters receive mode. This can be used to activate an external low noise amplifier to boost the receiver sensitivity. These external amplifiers can significantly increase the range of the system at the expense of higher current consumption and system cost.



## Mode Indicator

The Mode Indicator line (MODE\_IND) provides feedback about the current state of the module. This line switches at different rates depending on the module's current operation. When an LED is connected to this line it blinks, providing a visual indication to the user. Figure 34 gives the definitions of the MODE\_IND timings.

MODE_IND Timing	
Module Status	Display
Transmit Mode	Solid ON when transmitting packets.
Receive Mode	Solid ON when receiving packets.
Pair Search	ON for 100ms, OFF for 900ms while searching for another unit during the Pair process
Pair Found	ON for 400ms, OFF for 100ms when the transceiver has been Paired with another transceiver. This is displayed for at least 3 seconds.
Pair Error	ON for 100ms, OFF for 100ms when the address table is full and another unit cannot be added.
Remote Pair Error	ON for 100ms, OFF for 100ms, ON for 100ms OFF for 300ms when the remote unit's address table is full and a Pair cannot be completed.
Pair Cancelled	ON for 100ms, OFF for 200ms, ON for 100ms when the Pair process is cancelled.
Reset Acknowledgement	ON for 600ms, OFF for 100ms, ON for 200ms, OFF for 100ms, ON for 200ms and OFF for 100ms when the reset sequence is recognized.
Extended Pair Cancelled	Solid ON when the pairing operation is cancelled and waiting for the PAIR line to go low.

Figure 34: MODE\_IND Timing

## Reset to Factory Default

The transceiver is reset to factory default by taking the Pair line high briefly 4 times, then taking and holding Pair high for more than 3 seconds. Each brief interval must be high 0.1 to 2 seconds and low 0.1 to 2 seconds (1 second nominal high / low cycle). The sequence helps prevent accidental resets. Once the sequence is recognized the MODE\_IND line blinks the Reset Acknowledgement defined in Figure 34 until the PAIR line goes low. After the Reset Acknowledgement is shown and PAIR goes low, the configuration is initialized. Factory reset also clears the Paired Module table but does not change the local address. If the PAIR input timing doesn't match the reset sequence timing an Extended Pair Cancel sequence is shown when PAIR goes low. The module reverts to normal operation without a reset or pairing.

## Using the LVL\_ADJ Line

The Level Adjust (LVL\_ADJ) line allows the transceiver's output power to be easily adjusted for range control or lower power consumption. This is done by placing a voltage on the LVL\_ADJ line. This can be done using a voltage divider or a voltage source. When the transceiver powers up, the voltage on this line is measured and the output power level is set accordingly. When LVL\_ADJ is connected to  $V_{CC}$ , the output power and current consumption are the highest. When connected to ground, the output power and current are the lowest. See the Typical Performance Graphs section (Figure 6) for a graph of the output power vs. LVL\_ADJ voltage.

Even in designs where attenuation is not anticipated, it is a good idea to place resistor pads connected to LVL\_ADJ so that it can be used if needed. Figure 35 shows the voltages needed to set each power level and gives the approximate output power for each level. The output power levels are approximate and may vary part-to-part.

Power Level vs. LVL_ADJ Voltage Ratio		
$V_{LVL\_ADJ}/V_{CC}$ ratio	$P_{OUT}$ @ 915MHz	$P_{OUT}$ @ 2.4GHz
0.00	-19.83	-27.96
0.08	-15.46	-26.50
0.15	-15.48	-24.88
0.23	-10.59	-21.32
0.30	-10.60	-18.74
0.38	-6.05	-16.94
0.45	-6.03	-14.66
0.53	-0.95	-10.82
0.61	-0.96	-9.26
0.68	4.30	-7.39
0.76	4.29	-5.26
0.83	6.66	-1.99
0.91	9.84	0.57
0.98	9.84	1.73
1.00	9.83	1.73

Figure 35: Power Level vs. LVL\_ADJ Voltage Voltage Ratio

## Receiver Duty Cycle

The module can be configured to automatically power on and off while in receive mode. Instead of being powered on all the time looking for transmissions from an IU, the receiver can wake up, look for data and go back to sleep for a configurable amount of time. If it wakes up and receives valid data, then it stays on and goes back to sleep when the data stops. This significantly reduces the amount of current consumed by the receiver. It also increases the time from activating the IU to getting a response from the RU.

The duty cycle is controlled by the Duty Cycle serial command through the CDI. DCycle sets the number of seconds between receiver turn-on points as shown in Figure 36.

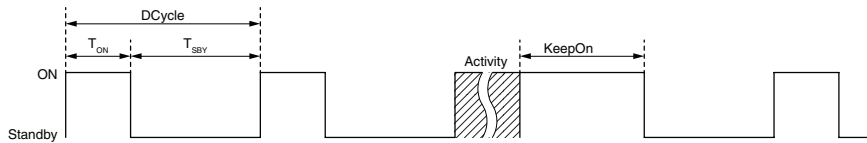

Figure 36: Receiver Duty Cycle

The module's average current consumption can be calculated with the following equation.

$$I_{AVG} = \frac{(T_{ON} \times I_{RX}) + (T_{SBY} \times I_{SBY})}{DCycle}$$

Figure 37: Receiver Duty Cycle Average Current Consumption Equation

$T_{ON}$  is fixed at about 0.326 seconds and  $T_{SBY} = DCycle - T_{ON}$ . The receiver current ( $I_{RX}$ ) and standby current ( $I_{SBY}$ ) vary with supply voltage, but some typical values are in Figure 38.

HumRC™ Series Typical Current Consumption				
$V_{CC}$ (VDC)		2.5	3.3	3.6
HUM-2.4-RC	$I_{RX}$ (mA)	21.45	21.82	22.03
	$I_{SBY}$ (mA)	0.00040	0.00058	0.00063
HUM-900-RC	$I_{RX}$ (mA)	22.94	23.73	24.02
	$I_{SBY}$ (mA)	0.00040	0.00058	0.00063

Figure 38: HumRC™ Series Transceiver Typical Current Consumption

Figure 20 and Figure 21 show graphs of the average current consumption vs. duty cycle for several supply voltages. They show that the average current consumption can be significantly reduced with even a small duty cycle value. This is ideal for battery-powered applications that need infrequent updates or where response time is not critical.

The KeepOn time is used to keep the receiver on after it has completed some activity. This activity includes completing a transmission and receiving a valid packet. After KeepOn seconds have elapsed with no transmit or valid receive activity, the module resumes duty cycle operation by going into standby for DCycle seconds.

Please see Reference Guide RG-00104: the HumRC™ Series Command Data Interface for details on configuring the receiver duty cycle.

## Using the LATCH\_EN Line

The LATCH\_EN line sets the outputs to either momentary operation or latched operation. During momentary operation the outputs go high for as long as control messages are received instructing the module to take the lines high. As soon as the control messages stop, the outputs go low.

During latched operation, when a signal is received to make a particular status line high, it remains high until a separate activation is received to make it go low. The transmission must stop and the module must time out before it will register a second transmission and toggle the outputs.

When the LATCH\_EN line is high, all of the outputs are latched. A serial command is available to configure latching of individual lines.

## Using the Low Power Features

The Power Down (POWER\_DOWN) line can be used to completely power down the transceiver module without the need for an external switch. This line allows easy control of the transceiver power state from external components, such as a microcontroller. The module is not functional while in power down mode.

If all of the status lines are configured as inputs, then the module operates as an IU only. It automatically goes into a low power state waiting for one of the inputs to be asserted. This conserves battery power until a transmission is required.

## Triggered Transmissions

The HumRC™ Series Transceiver has a triggered transmission feature configured through the serial interface. This causes the IU to transmit messages as soon as a configured status line input goes high, but stop transmissions based on configuration selection. The logic allows timed or periodic transmissions for simple transmit-on-event conditions without an external microcontroller or other timing logic. This reduces the required energy and potential interference with other RF units when automatically transmitting. The configuration options are:

1. Transmission occurs as long as input is high. This is the same as normal, non-triggered operation.
2. Transmission lasts for the specified duration after a high-going edge, then stops until the next high-going edge (fixed ON period).
3. Transmission starts when an input goes high, stopping when the input goes low or the specified duration elapses, whichever occurs first. The transmission won't occur again until the input goes low, then high.
4. Transmission is periodic, with configured duration and interval, as long as the trigger status line is high (periodic ON when trigger is high).
5. The transmission terminates under conditions 1–4 above, or when an ACK is received. After an ACK no further trigger transmission occurs until the triggered status line goes low, then high again.
6. The transmission is periodic, like condition 4, but each transmission duration is terminated by receiving an acknowledgement.

A status input not selected for trigger timing operates normally, transmitting as long as the input is high. It doesn't affect the timing of periodic transmissions, causing the two transmission requests to be logically ORed.

Receiving control messages during the off period of a triggered periodic transmission can delay, but doesn't cancel periodic transmission.

If there are multiple lines with edge triggers, they are logically ORed together to generate a single trigger signal.

Please see Reference Guide RG-00104: the HumRC™ Series Command Data Interface for details on configuring triggered transmissions.

## Frequency Hopping

The module incorporates a Frequency Hopping Spread Spectrum (FHSS) algorithm. This provides immunity from narrow-band interference and complies with FCC and IC guidelines.

The module uses 25 RF channels as shown in Figure 39. Each channel has a time slot of 13.33ms before the module hops to the next channel. This equal spacing allows a receiver to hop to the next channel at the correct time even if a packet is missed. Up to seven consecutive packets can be missed without losing synchronization.

The hopping pattern (sequence of transmit channels) is determined from the transmitter's address. Each sequence uses all 25 channels, but in different orders. Once a transmission starts, the module continues through a complete cycle. If the input line is taken low in the middle of a cycle, the module continues transmitting through the end of the cycle to ensure balanced use of all channels.

Frequency hopping has several advantages over single channel operation. Hopping systems are allowed a higher transmitter output power, which results in longer range and better performance within that range. Since the transmission is moving among multiple channels, interference on one channel causes loss on that channel but does not corrupt the entire link. This improves the reliability of the system.

Channel Frequencies		
Channel Number	HUM-2.4-RC Frequency (MHz)	HUM-900-RC Frequency (MHz)
1	2,420.25	902.750
2	2,422.25	903.250
3	2,424.25	903.750
4	2,426.25	904.250
5	2,428.25	904.750
6	2,430.25	905.249
7	2,432.25	905.749
8	2,434.25	906.249
9	2,436.25	906.749
10	2,438.25	907.249
11	2,440.25	907.749
12	2,442.25	908.249
13	2,444.25	908.749
14	2,446.25	909.248
15	2,448.25	909.748
16	2,450.25	910.248
17	2,452.25	910.748
18	2,454.25	911.248
19	2,456.25	911.748
20	2,458.25	912.248
21	2,460.25	912.748
22	2,462.25	913.247
23	2,464.25	913.747
24	2,466.25	914.247
25	2,468.25	914.747

Figure 39: HumRC™ Series Transceiver RF Channel Frequencies

## The Command Data Interface

The HumRC™ Series transceiver has a serial Command Data Interface (CDI) that offers the option to configure and control the transceiver through software instead of through hardware. This interface consists of a standard UART with a serial command set. This allows for fewer connections in applications controlled by a microcontroller as well as for more control and advanced features than can be offered through hardware pins alone.

The CMD\_DATA\_IN and CMD\_DATA\_OUT connect to the module's UART. An automatic baud rate detection system allows the interface to run at a variable data rate from 9.0kbps to 60.0kbps, covering standard rates from 9.6 to 57.6kbps.

The Command Data Interface has two sets of operators. One is a set of commands that performs specific tasks and the other is a set of parameters that are for module configuration and status reporting.

The HumRC™ Series Transceiver Command Data Interface Reference Guide has full details on each command. Some key features available with the serial interface are:

- Configure the module through software instead of setting the hardware lines.
- Change the output power, providing the ability to lower power consumption when signal levels are good and extend battery life.
- Individually set which status lines are inputs and outputs.
- Individually set status line outputs to operate as momentary or latched.
- Add or remove specific paired devices.
- Individually set Permission Masks that prevent certain paired devices from activating certain status line outputs.
- Change the module's local address for production or tracking purposes or to replace a lost or broken product.
- Put the module into a low power state to conserve battery power.

- Activate an automatic receiver duty cycle to conserve battery power.
- Receive the entire control message serially instead of needing to monitor individual status lines. Get the IU address for logging access attempts.
- Receive control messages from unpaired modules, allowing for expansion of the system beyond the maximum of 40 paired units. Access control and address validation can be undertaken by an external processor or PC with more memory than the module.
- Serially configure and control acknowledge messages.
- Send and receive 2 bytes (16 bits) of custom data with each command message and acknowledge message.
- Serially initiate transmission of control messages instead of triggering the status line inputs.
- Set interrupts to notify an external processor when specific events occur, such as receiving a control message.
- Read out the RSSI value for the last received packet and the current ambient RF level.
- Query a remote unit to respond with its analog input voltage measurements.
- Configure the module to send triggered control messages that automatically stop transmitting based on the settings, conserving battery power.

The serial interface offers a great deal of flexibility for more complicated designs. Please see Reference Guide RG-00104: the HumRC™ Series Command Data Interface for details on the CDI. Lists of the serial commands and parameters are shown in Figure 40 and Figure 41 for reference.

## Serial Setup Configuration for Stand-alone Operation

The serial interface offers access to a number of advanced features that cannot be controlled through hardware configuration alone. However, not all products need or use a microcontroller or processor, but would benefit from some of the advanced features.

Many of the configuration settings can be written once and then used by the module thereafter. This allows the modules to be configured through a temporary serial connection and then operate in a stand-alone fashion without a permanent serial connection.

For example, a product can have a small header or connector so that the serial lines can be connected to a PC in production test. The PC writes the configurations required by the application to the module and is then disconnected. The module uses these configurations in its normal operation.

Command Data Interface Commands	
Command	Description
Read	Read the current value in volatile memory. If there is no volatile value, then the non-volatile value is returned.
Write	Write a new value to volatile memory.
Read NV	Read the value in non-volatile memory.
Program	Program a new value to non-volatile memory.
Set Default Configuration	Set all configuration items to their factory default values.
Erase All Addresses	Erase all paired addresses from memory.
Transmit Control Data	Transmit a control message.
Transmit ACK	Transmit an acknowledgement for received data.
Transmit AWD	Transmit an Acknowledge With Data (AWD) response with two bytes of custom data.
Transmit IU Packet	Transmit a general IU packet.
NV Update	Write all NV changes to NV memory
Pair Control	Initiate / Cancel RF Pairing with another module

Figure 40: HumRC™ Series Transceiver Command Data Interface Commands

Command Data Interface Parameters	
Parameter	Description
Device Name	NULL-terminated string of up to 16 characters that identifies the module. Read only.
Firmware Version	2 byte firmware version. Read only.
Serial Number	4 byte factory-set serial number. Read only.
Local Address	The module's 32-bit local address.
Status Line I/O Mask	Status lines direction (1 = Inputs, 0 = Outputs), LSB = S0, used when enabled by Control Source.
Latch Mask	Latching enable for output lines, LSB = S0, used when enabled by Control Source.
TX Power Level	TX output power, signed nominal dBm, used when enabled by Control Source.
Control Source	Configures the control options.
Message Select	Select message types to capture for serial readout.
Analog Input Select	Define analog sources, averaging, reference, and offset for analog readings.
Custom Data Source	Source of transmitted custom data.
Paired Module Descriptor	Sets the address and permissions mask of paired modules.
Trigger Operation	Input Trigger operation.
Receiver Duty Cycle	Receiver Duty Cycle control.
I/O Lines	Read the current state of the status and control lines. Read only.
RSSI	Read the RSSI of the last packet received and ambient level. Read only.
LADJ	Read the voltage on the LVL_ADJ line. Read only.
Module Status	Read the operating status of the module. Read only.
Captured Receive Packet	Read the last received packet. Read only.
Interrupt Mask	Sets the mask for events to generate a break on CMD_DATA_OUT.
Event Flags	Event flags that are used with the Interrupt Mask.
Analog Input Reading	Readout of the analog input lines. Read only.
Trigger Input Status	Status of Trigger Inputs. Read only.
Pairing Status	Status of Last Pair attempt since power-up. Read only.

Figure 41: HumRC™ Series Transceiver Command Data Interface Parameters

## Basic Hardware Operation

The following steps describe how to use the HumRC™ Series module with hardware only. Basic application circuits that correspond to these steps are shown in Figure 42.

1. Set the C0 and C1 lines opposite on both sides.
2. Press the PAIR button on both sides. The MODE\_IND LED begins flashing slowly to indicate that the module is searching for another module.
3. Once the pairing is complete, the MODE\_IND LED flashes quickly to indicate that the pairing was successful.
4. The modules are now paired and ready for normal use.
5. Pressing a status line button on one module (the IU) activates the corresponding status line output on the second module (the RU).
6. Taking the ACK\_EN line high on the RU causes the module to send an acknowledgement to the IU. The ACK\_OUT line on the IU goes high to indicate that the acknowledgement has been received. Tying the line to  $V_{cc}$  causes the module to send an acknowledgement as soon as a command message is received.

This is suitable for basic remote control or command systems. No programming is necessary for basic hardware operation. The Typical Applications section shows additional example schematics for using the modules.

The Command Data Interface section describes the more advanced features that are available with the serial interface.

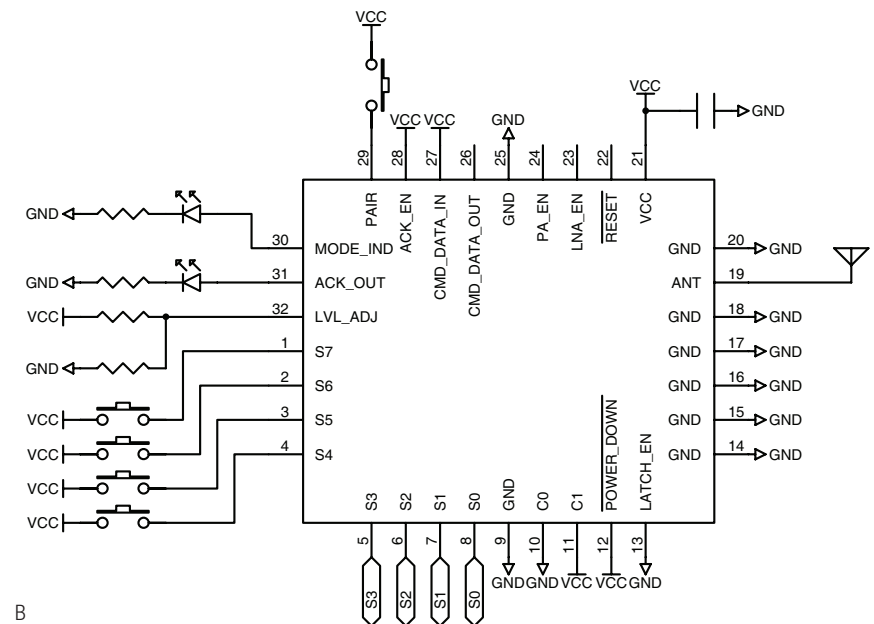
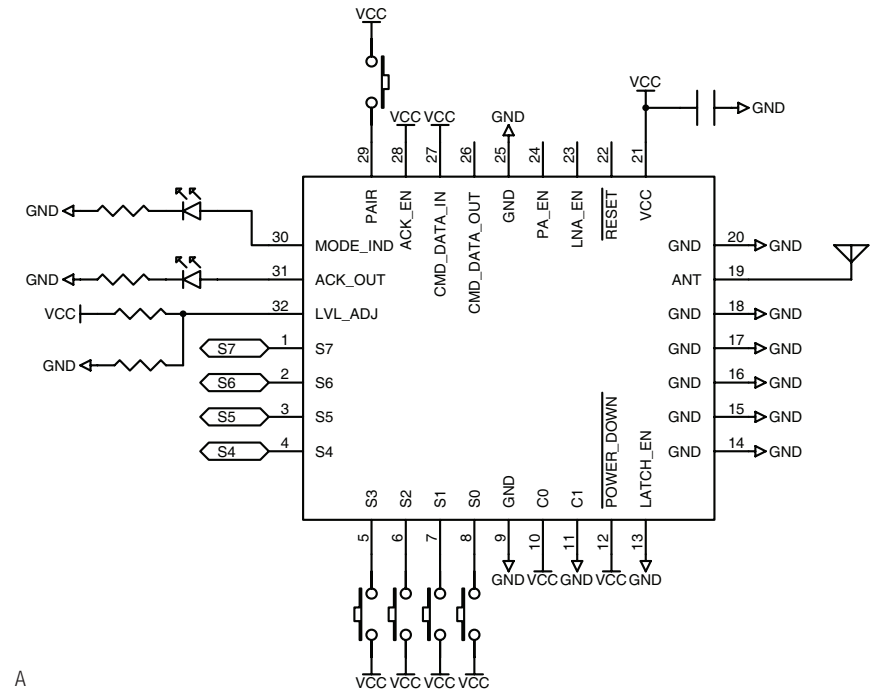

Figure 42: HumRC™ Series Transceiver Basic Application Circuits for Bi-directional Remote Control

## Typical Applications

Figure 43 and Figure 44 show circuits using the HumRC™ Series transceiver.

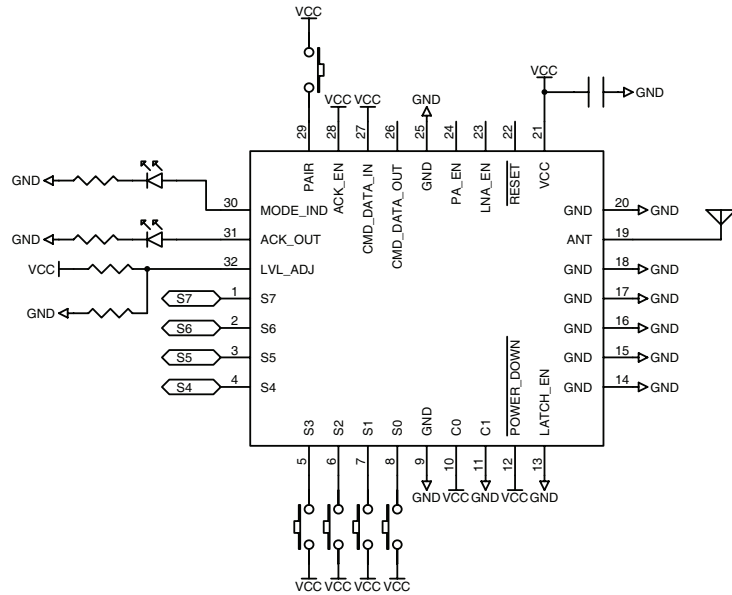

Figure 43: HumRC™ Series Transceiver Basic Application Circuit

In this example, C0 is high and C1 is low, so S0–S3 are inputs and S4–S7 are outputs. The inputs are connected to buttons that pull the lines high and weak pull-down resistors to keep the lines from floating when the buttons are not pressed. The outputs would be connected to external application circuitry.

LATCH\_EN is low, so the outputs are momentary.

The Command Data Interface is not used in this design, so CMD\_DATA\_IN is tied high and CMD\_DATA\_OUT is not connected.

ACK\_OUT and MODE\_IND are connected to LEDs to provide visual indication to the user.

PAIR is connected to a button and pull-down resistor to initiate the Pair Process when the button is pressed.

ACK\_EN is tied high so the module sends acknowledgements as soon as it receives a control message.

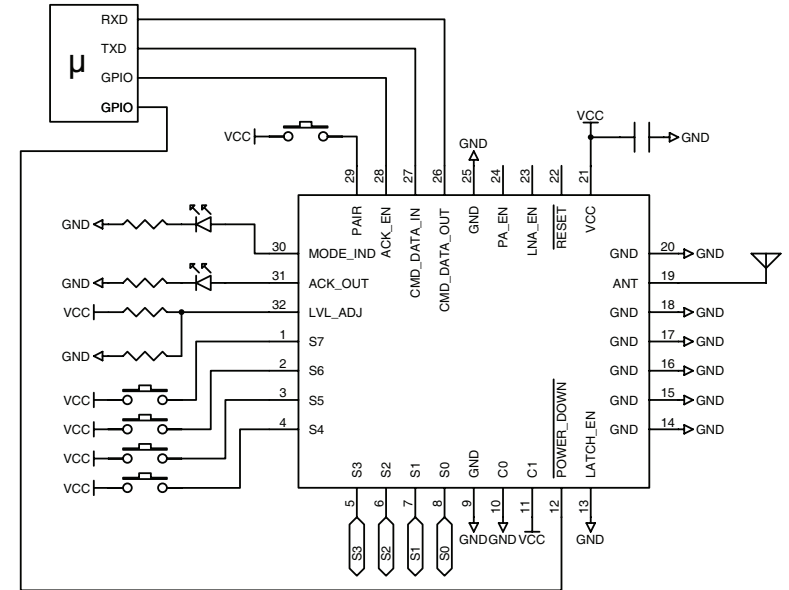

Figure 44: HumRC™ Series Transceiver Typical Application Circuit with External Microprocessor

In this example, C0 is low and C1 is high, so S0–S3 are outputs and S4–S7 are inputs. This is inverted from the circuit in Figure 43 making it the matching device.

In this circuit, the Command Data Interface is connected to a microcontroller for using some of the advanced features.

The microcontroller controls the state of the ACK\_EN line. It can receive a command, perform an action and then take the line high to send Acknowledgement packets. This lets the user on the other end know that the action took place and not just that the command was received.



## Usage Guidelines for FCC and IC Compliance

The pre-certified versions of the HumRC™ Series module (HUM-900-RC-UFL and HUM-900-RC-CAS) are provided with an FCC and Industry Canada Modular Certification. This certification shows that the module meets the requirements of FCC Part 15 and Industry Canada license-exempt RSS standards for an intentional radiator. The integrator does not need to conduct any further intentional radiator testing under these rules provided that the following guidelines are met:

- An approved antenna must be directly coupled to the module's U.FL connector through an approved coaxial extension cable or to the module's castellation pad using an approved reference design and PCB layer stack.
- Alternate antennas can be used, but may require the integrator to perform certification testing.
- The module must not be modified in any way. Coupling of external circuitry must not bypass the provided connectors.
- End product must be externally labeled with "Contains FCC ID: OJM900MCA / IC: 5840A-900MCA".
- The end product's user's manual must contain an FCC statement equivalent to that listed on page page 45 of this data guide.
- The antenna used for this transceiver must not be co-located or operating in conjunction with any other antenna or transmitter.
- The integrator must not provide any information to the end-user on how to install or remove the module from the end-product.

Any changes or modifications not expressly approved by Linx Technologies could void the user's authority to operate the equipment.

## Additional Testing Requirements

The HUM-900-RC-UFL and HUM-900-RC-CAS modules have been tested for compliance as an intentional radiator, but the integrator is required to perform unintentional radiator testing on the final product per FCC sections 15.107 and 15.109 and Industry Canada license-exempt RSS standards. Additional product-specific testing might be required. Please contact the FCC or Industry Canada regarding regulatory requirements for the application. Ultimately it is the integrator's responsibility to show that their product complies with the regulations applicable to their product. **Versions other than the -UFL and -CAS have not been tested and require full compliance testing in the end product as it will go to market.**

## Information to the user

The following information must be included in the product's user manual.

### FCC / IC NOTICES

This product contains FCC ID: OJM900MCA / IC: 5840A-900MCA.

This device complies with Part 15 of the FCC rules and Industry Canada license-exempt RSS standards. Operation of this device is subject to the following two conditions:

1. This device may not cause harmful interference, and
2. this device must accept any interference received, including interference that may cause undesired operation.

This equipment has been tested and found to comply with the limits for a Class B digital device, pursuant to Part 15 of the FCC Rules. These limits are designed to provide reasonable protection against harmful interference in a residential installation. This equipment generates, uses and can radiate radio frequency energy and, if not installed and used in accordance with the instructions, may cause harmful interference to radio communications. However, there is no guarantee that interference will not occur in a particular installation. If this equipment does cause harmful interference to radio or television reception, which can be determined by turning the equipment off and on, the user is encouraged to try to correct the interference by one or more of the following measures:

- Reorient or relocate the receiving antenna.
- Increase the separation between the equipment and receiver.
- Connect the equipment into an outlet on a circuit different from that to which the receiver is connected.
- Consult the dealer or an experienced radio/TV technician for help.

Any modifications could void the user's authority to operate the equipment.

Le présent appareil est conforme aux CNR d'Industrie Canada applicables aux appareils radio exempts de licence. L'exploitation est autorisée aux deux conditions suivantes:

1. l'appareil ne doit pas produire de brouillage, et
2. l'utilisateur de l'appareil doit accepter tout brouillage radioélectrique subi, même si le brouillage est susceptible d'en compromettre le fonctionnement.

## Product Labeling

The end product containing the HUM-900-RC-UFL or HUM-900-RC-CAS must be labeled to meet the FCC and IC product label requirements. It must have the below or similar text:

Contains FCC ID: OJM900MCA / IC: 5840A-900MCA

The label must be permanently affixed to the product and readily visible to the user. “Permanently affixed” means that the label is etched, engraved, stamped, silkscreened, indelibly printed, or otherwise permanently marked on a permanently attached part of the equipment or on a nameplate of metal, plastic, or other material fastened to the equipment by welding, riveting, or a permanent adhesive. The label must be designed to last the expected lifetime of the equipment in the environment in which the equipment may be operated and must not be readily detachable.

## FCC RF Exposure Statement

To satisfy RF exposure requirements, this device and its antenna must operate with a separation distance of at least 20cm from all persons and must not be co-located or operating in conjunction with any other antenna or transmitter.

## Antenna Selection

Under FCC and Industry Canada regulations, the HUM-900-RC-UFL and HUM-900-RC-CAS radio transmitters may only operate using an antenna of a type and maximum (or lesser) gain approved for the transmitter by the FCC and Industry Canada. To reduce potential radio interference to other users, the antenna type and its gain should be so chosen that the equivalent isotropically radiated power (e.i.r.p.) is not more than that necessary for successful communication.

The HUM-900-RC-UFL and HUM-900-RC-CAS radio transmitters have been approved by the FCC and Industry Canada to operate with the antenna types listed in Figure 45 with the maximum permissible gain and required antenna impedance for each antenna type indicated. Antenna types not included in this list, having a gain greater than the maximum gain indicated for that type, are strictly prohibited for use with this device.

Conformément à la réglementation d’Industrie Canada, le présent émetteur radio peut fonctionner avec une antenne d’un type et d’un gain maximal (ou inférieur) approuvé pour l’émetteur par Industrie Canada. Dans le but de réduire les risques de brouillage radioélectrique à l’intention des autres

utilisateurs, il faut choisir le type d’antenne et son gain de sorte que la puissance isotrope rayonnée équivalente (p.i.r.e.) ne dépasse pas l’intensité nécessaire à l’établissement d’une communication satisfaisante.

Le présent émetteur radio (HUM-900-RC-UFL, HUM-900-RC-CAS) a été approuvé par Industrie Canada pour fonctionner avec les types d’antenne énumérés la Figure 45 et ayant un gain admissible maximal et l’impédance requise pour chaque type d’antenne. Les types d’antenne non inclus dans cette liste, ou dont le gain est supérieur au gain maximal indiqué, sont strictement interdits pour l’exploitation de l’émetteur.

Antennas / Antennes				
Linx Part Number Référence Linx	Type	Gain	Impedance Impédance	Valid For
<b>Tested Antennas</b>				
ANT-916-CW-QW	¼ Wave Whip	1.8dBi	50Ω	–CAS
ANT-916-CW-HW	½ Wave Dipole Helical	1.2dBi	50Ω	Both
ANT-916-PW-LP	¼ Wave Whip	2.4dBi	50Ω	–CAS
ANT-916-PW-QW-UFL	¼ Wave Whip	1.8dBi	50Ω	–UFL
ANT-916-SP	¼ Wave Planar	1.4dBi	50Ω	–CAS
ANT-916-WRT-RPS ANT-916-WRT-UFL	½ Wave Dipole Helical	–0.1dBi	50Ω	–CAS –UFL
<b>Antennas of the same type and same or lesser gain</b>				
ANT-916-CW-HD	¼ Wave Whip	–0.3dBi	50Ω	Both
ANT-916-PW-QW	¼ Wave Whip	1.8dBi	50Ω	Both
ANT-916-CW-RCL	¼ Wave Whip	–2.0dBi	50Ω	Both
ANT-916-CW-RH	¼ Wave Whip	–1.3dBi	50Ω	Both
ANT-916-CW-HWR-RPS	½ Wave Dipole Helical	1.2dBi	50Ω	Both
ANT-916-PML	½ Wave Dipole Helical	–0.4dBi	50Ω	Both
ANT-916-PW-RA	¼ Wave Whip	0.0dBi	50Ω	–CAS
ANT-916-USP	¼ Wave Planar	0.3dBi	50Ω	–CAS
Cable Assemblies / Assemblages de Câbles				
Linx Part Number Référence Linx	Description			
CSI-RSFB-300-UFFR*	RP-SMA Bulkhead to U.FL with 300mm cable			
CSI-RSFE-300-UFFR*	RP-SMA External Mount Bulkhead to U.FL with 300mm cable			
* Also available in 100mm and 200mm cable length				

Figure 45: HumRC™ Series Transceiver Approved Antennas

## Castellation Version Reference Design

The castellation connection for the antenna on the pre-certified version allows the use of embedded antennas as well as removes the cost of a cable assembly for the u.FL connector. However, **the PCB design and layer stack must follow one of the reference designs for the certification on the HUM-900-RC-CAS to be valid.** Figure 46 shows the PCB layer stack that should be used. Figure 47 shows the layout and routing designs for the different antenna options. Please see the antenna data sheets for specific ground plane counterpoise requirements.

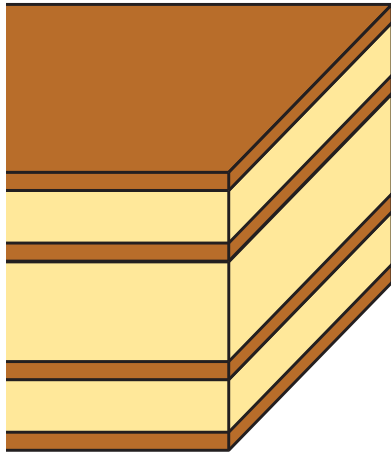

Layer Name	Thickness	Material
Top Layer	1.4mil	Copper
Dielectric 1	14.00mil	FR-4 (Er = 4.6)
Mid-Layer 1	1.4mil	Copper
Dielectric 2	28.00mil	FR-4 (Er = 4.6)
Mid-Layer 2	1.4mil	Copper
Dielectric 3	14.00mil	FR-4 (Er = 4.6)
Bottom Layer	1.4mil	Copper

Figure 46: HumRC™ Series Transceiver Castellation Version Reference Design PCB Stack

**Note:** The PCB design and layer stack for the HUM-900-RC-CAS must follow these reference designs for the pre-certification to be valid.

The HUM-900-RC-UFL and the HUM-900-RC-CAS must use one of the antennas in Figure 45 in order for the certification to be valid.

The HUM-900-RC and HUM-2.4-RC have not been tested and require full compliance testing in the end product as it will go to market.

All modules require unintentional radiator compliance testing in the end product as it will go to market.

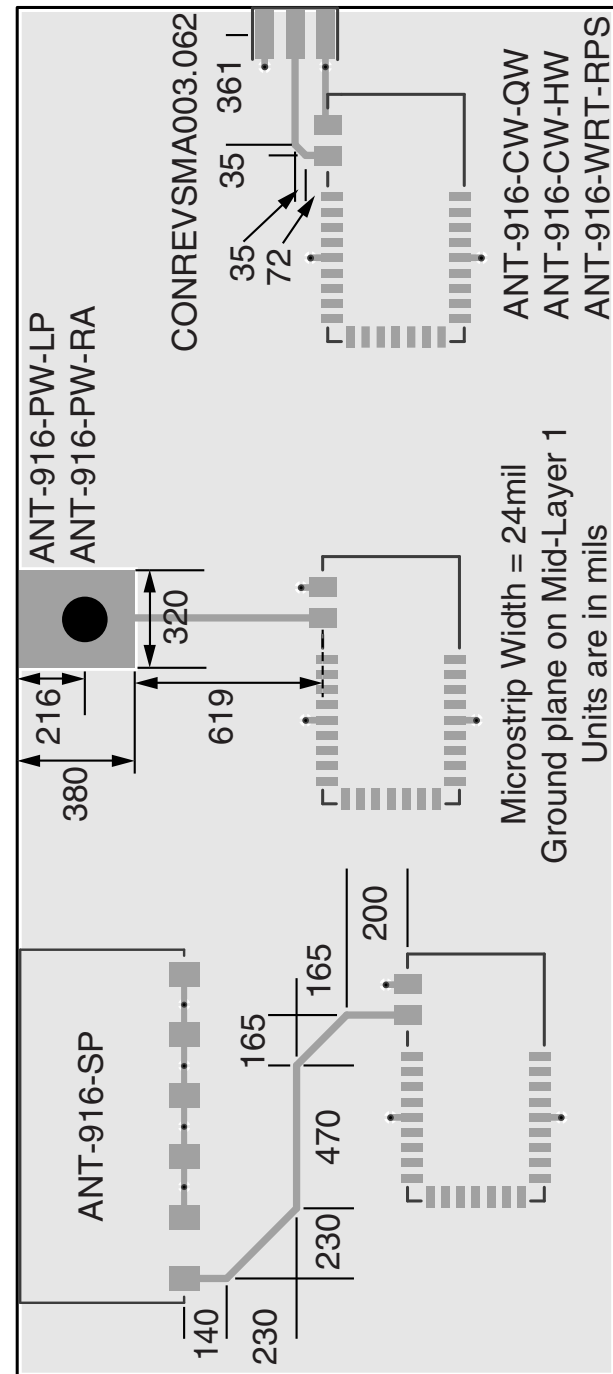

Figure 47: HumRC™ Series Transceiver Castellation Version Reference Design

## Power Supply Requirements

The module does not have an internal voltage regulator, therefore it requires a clean, well-regulated power source. The power supply noise should be less than 20mV. Power supply noise can significantly affect the module's performance, so providing a clean power supply for the module should be a high priority during design.

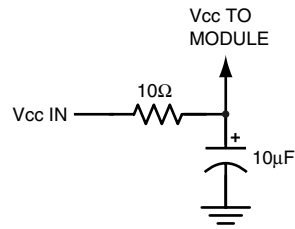

Figure 48: Supply Filter

A 10Ω resistor in series with the supply followed by a 10μF tantalum capacitor from  $V_{cc}$  to ground helps in cases where the quality of supply power is poor (Figure 48). This filter should be placed close to the module's supply lines. These values may need to be adjusted depending on the noise present on the supply line.

## Antenna Considerations

The choice of antennas is a critical and often overlooked design consideration. The range, performance and legality of an RF link are critically dependent upon the antenna. While adequate antenna performance can often be obtained by trial and error methods, antenna design and matching is a complex task. Professionally designed antennas such as those from Linx (Figure 49) help ensure maximum performance and FCC and other regulatory compliance. Please see "General Antenna Rules" for more information.



Figure 49: Linx Antennas

It is usually best to utilize a basic quarter-wave whip until your prototype product is operating satisfactorily. Other antennas can then be evaluated based on the cost, size and cosmetic requirements of the product. Additional details are in Application Note AN-00500.

## Interference Considerations

The RF spectrum is crowded and the potential for conflict with unwanted sources of RF is very real. While all RF products are at risk from interference, its effects can be minimized by better understanding its characteristics.

Interference may come from internal or external sources. The first step is to eliminate interference from noise sources on the board. This means paying careful attention to layout, grounding, filtering and bypassing in order to eliminate all radiated and conducted interference paths. For many products, this is straightforward; however, products containing components such as switching power supplies, motors, crystals and other potential sources of noise must be approached with care. Comparing your own design with a Linx evaluation board can help to determine if and at what level design-specific interference is present.

External interference can manifest itself in a variety of ways. Low-level interference produces noise and hashing on the output and reduces the link's overall range.

High-level interference is caused by nearby products sharing the same frequency or from near-band high-power devices. It can even come from your own products if more than one transmitter is active in the same area. It is important to remember that only one transmitter at a time can occupy a frequency, regardless of the coding of the transmitted signal. This type of interference is less common than those mentioned previously, but in severe cases it can prevent all useful function of the affected device.

Although technically not interference, multipath is also a factor to be understood. Multipath is a term used to refer to the signal cancellation effects that occur when RF waves arrive at the receiver in different phase relationships. This effect is a particularly significant factor in interior environments where objects provide many different signal reflection paths. Multipath cancellation results in lowered signal levels at the receiver and shorter useful distances for the link.

## Pad Layout

The pad layout diagrams below are designed to facilitate both hand and automated assembly. Figure 50 shows the footprint for the smaller version and Figure 51 shows the footprint for the pre-certified version.

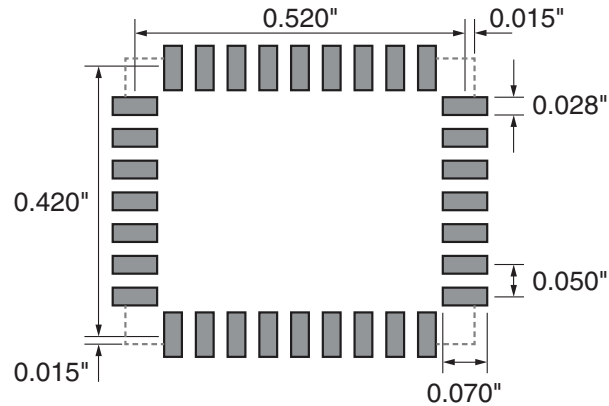

Figure 50: HUM-\*\*\*-RC Recommended PCB Layout

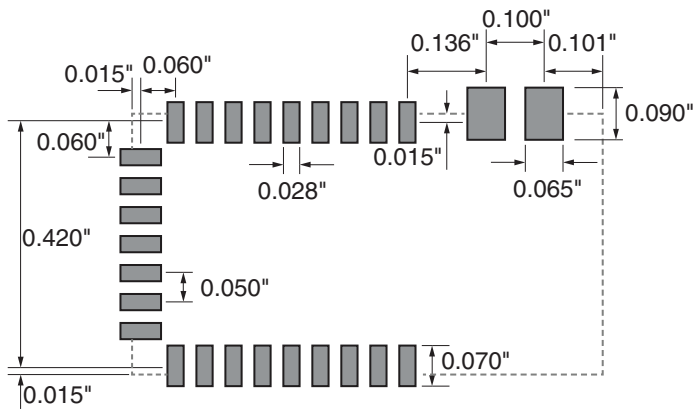

Figure 51: HUM-\*\*\*-RC-UFL/CAS Recommended PCB Layout

## Microstrip Details

A transmission line is a medium whereby RF energy is transferred from one place to another with minimal loss. This is a critical factor, especially in high-frequency products like Linx RF modules, because the trace leading to the module's antenna can effectively contribute to the length of the antenna, changing its resonant bandwidth. In order to minimize loss and detuning, some form of transmission line between the antenna and the module should be used unless the antenna can be placed very close (<1/8in) to the module. One common form of transmission line is a coax cable and another is the microstrip. This term refers to a PCB trace running over a ground plane that is designed to serve as a transmission line between the module and the antenna. The width is based on the desired characteristic impedance of the line, the thickness of the PCB and the dielectric constant of the board material. For standard 0.062in thick FR-4 board material, the trace width would be 111 mils. The correct trace width can be calculated for other widths and materials using the information in Figure 52 and examples are provided in Figure 53. Software for calculating microstrip lines is also available on the Linx website.

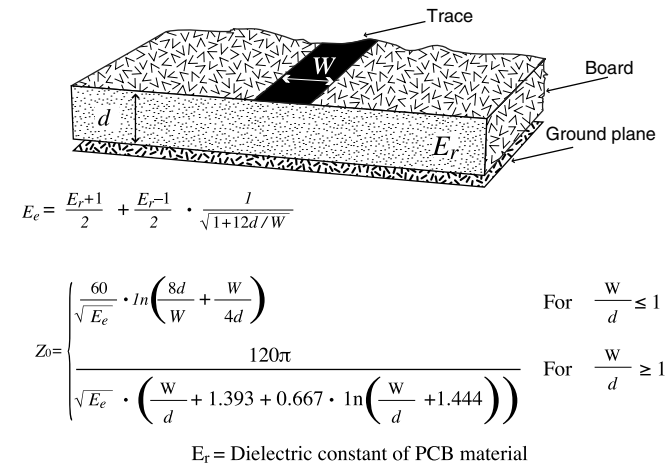

Figure 52: Microstrip Formulas

### Example Microstrip Calculations

Dielectric Constant	Width / Height Ratio (W / d)	Effective Dielectric Constant	Characteristic Impedance ( $\Omega$ )
4.80	1.8	3.59	50.0
4.00	2.0	3.07	51.0
2.55	3.0	2.12	48.8

Figure 53: Example Microstrip Calculations

## Board Layout Guidelines

The module's design makes integration straightforward; however, it is still critical to exercise care in PCB layout. Failure to observe good layout techniques can result in a significant degradation of the module's performance. A primary layout goal is to maintain a characteristic 50-ohm impedance throughout the path from the antenna to the module. Grounding, filtering, decoupling, routing and PCB stack-up are also important considerations for any RF design. The following section provides some basic design guidelines.

During prototyping, the module should be soldered to a properly laid-out circuit board. The use of prototyping or "perf" boards results in poor performance and is strongly discouraged. Likewise, the use of sockets can have a negative impact on the performance of the module and is discouraged.

The module should, as much as reasonably possible, be isolated from other components on your PCB, especially high-frequency circuitry such as crystal oscillators, switching power supplies, and high-speed bus lines.

When possible, separate RF and digital circuits into different PCB regions.

Make sure internal wiring is routed away from the module and antenna and is secured to prevent displacement.

Do not route PCB traces directly under the module. There should not be any copper or traces under the module on the same layer as the module, just bare PCB. The underside of the module has traces and vias that could short or couple to traces on the product's circuit board.

The Pad Layout section shows a typical PCB footprint for the module. A ground plane (as large and uninterrupted as possible) should be placed on a lower layer of your PC board opposite the module. This plane is essential for creating a low impedance return for ground and consistent stripline performance.

Use care in routing the RF trace between the module and the antenna or connector. Keep the trace as short as possible. Do not pass it under the module or any other component. Do not route the antenna trace on multiple PCB layers as vias add inductance. Vias are acceptable for tying together ground layers and component grounds and should be used in multiples. The -CAS version must follow the layout in Figure 47.

Each of the module's ground pins should have short traces tying immediately to the ground plane through a via.

Bypass caps should be low ESR ceramic types and located directly adjacent to the pin they are serving.

A 50-ohm coax should be used for connection to an external antenna. A 50-ohm transmission line, such as a microstrip, stripline or coplanar waveguide should be used for routing RF on the PCB. The Microstrip Details section provides additional information.

In some instances, a designer may wish to encapsulate or "pot" the product. There are a wide variety of potting compounds with varying dielectric properties. Since such compounds can considerably impact RF performance and the ability to rework or service the product, it is the responsibility of the designer to evaluate and qualify the impact and suitability of such materials.

## Helpful Application Notes from Linx

It is not the intention of this manual to address in depth many of the issues that should be considered to ensure that the modules function correctly and deliver the maximum possible performance. We recommend reading the application notes listed in Figure 54 which address in depth key areas of RF design and application of Linx products. These applications notes are available online at [www.linxtechnologies.com](http://www.linxtechnologies.com) or by contacting the Linx literature department.

Helpful Application Note Titles	
Note Number	Note Title
AN-00100	RF 101: Information for the RF Challenged
AN-00126	Considerations for Operation Within the 902–928MHz Band
AN-00130	Modulation Techniques for Low-Cost RF Data Links
AN-00140	The FCC Road: Part 15 from Concept to Approval
AN-00500	Antennas: Design, Application, Performance
AN-00501	Understanding Antenna Specifications and Operation
RG-00104	RC Series Transceiver Command Data Interface Reference Guide

Figure 54: Helpful Application Note Titles

## Production Guidelines

The module is housed in a hybrid SMD package that supports hand and automated assembly techniques. Since the modules contain discrete components internally, the assembly procedures are critical to ensuring the reliable function of the modules. The following procedures should be reviewed with and practiced by all assembly personnel.

## Hand Assembly

Pads located on the bottom of the module are the primary mounting surface (Figure 55). Since these pads are inaccessible during mounting, castellations that run up the side of the module have been provided to facilitate solder wicking to the module's underside. This allows for very

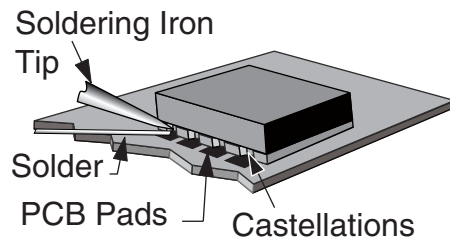

Figure 55: Soldering Technique

quick hand soldering for prototyping and small volume production. If the recommended pad guidelines have been followed, the pads will protrude slightly past the edge of the module. Use a fine soldering tip to heat the board pad and the castellation, then introduce solder to the pad at the module's edge. The solder will wick underneath the module, providing reliable attachment. Tack one module corner first and then work around the device, taking care not to exceed the times in Figure 56.

**Warning:** Pay attention to the absolute maximum solder times.

### Absolute Maximum Solder Times

Hand Solder Temperature: +427°C for 10 seconds for lead-free alloys

Reflow Oven: +255°C max (see Figure 57)

Figure 56: Absolute Maximum Solder Times

## Automated Assembly

For high-volume assembly, the modules are generally auto-placed. The modules have been designed to maintain compatibility with reflow processing techniques; however, due to their hybrid nature, certain aspects of the assembly process are far more critical than for other component types. Following are brief discussions of the three primary areas where caution must be observed.

## Reflow Temperature Profile

The single most critical stage in the automated assembly process is the reflow stage. The reflow profile in Figure 57 should not be exceeded because excessive temperatures or transport times during reflow will irreparably damage the modules. Assembly personnel need to pay careful attention to the oven's profile to ensure that it meets the requirements necessary to successfully reflow all components while still remaining within the limits mandated by the modules. The figure below shows the recommended reflow oven profile for the modules.

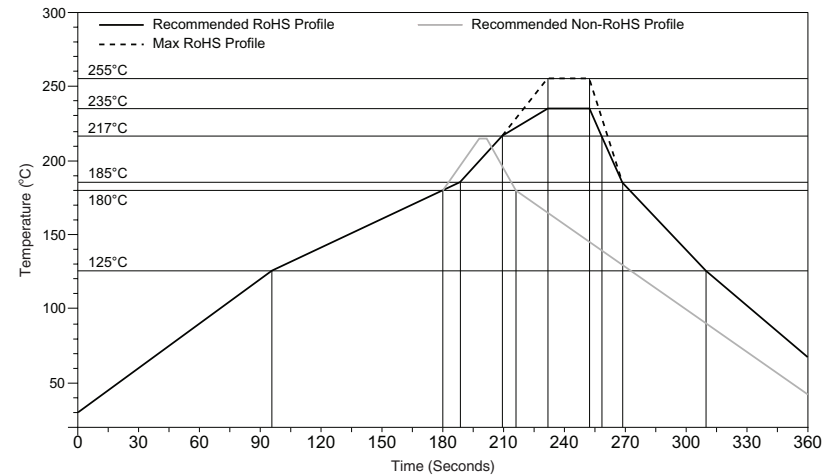

Figure 57: Maximum Reflow Temperature Profile

## Shock During Reflow Transport

Since some internal module components may reflow along with the components placed on the board being assembled, it is imperative that the modules not be subjected to shock or vibration during the time solder is liquid. Should a shock be applied, some internal components could be lifted from their pads, causing the module to not function properly.

## Washability

The modules are wash-resistant, but are not hermetically sealed. Linx recommends wash-free manufacturing; however, the modules can be subjected to a wash cycle provided that a drying time is allowed prior to applying electrical power to the modules. The drying time should be sufficient to allow any moisture that may have migrated into the module to evaporate, thus eliminating the potential for shorting damage during power-up or testing. If the wash contains contaminants, the performance may be adversely affected, even after drying.

## General Antenna Rules

The following general rules should help in maximizing antenna performance.

1. Proximity to objects such as a user's hand, body or metal objects will cause an antenna to detune. For this reason, the antenna shaft and tip should be positioned as far away from such objects as possible.
2. Optimum performance is obtained from a  $\frac{1}{4}$ - or  $\frac{1}{2}$ -wave straight whip mounted at a right angle to the ground plane (Figure 58). In many cases, this isn't desirable for practical or ergonomic reasons, thus, an alternative antenna style such as a helical, loop or patch may be utilized and the corresponding sacrifice in performance accepted.

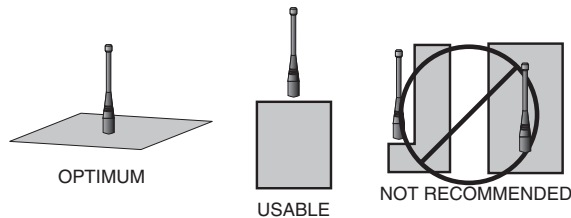

Figure 58: Ground Plane Orientation

3. If an internal antenna is to be used, keep it away from other metal components, particularly large items like transformers, batteries, PCB tracks and ground planes. In many cases, the space around the antenna is as important as the antenna itself. Objects in close proximity to the antenna can cause direct detuning, while those farther away will alter the antenna's symmetry.
4. In many antenna designs, particularly  $\frac{1}{4}$ -wave whips, the ground plane acts as a counterpoise, forming, in essence, a  $\frac{1}{2}$ -wave dipole (Figure 59). For this reason, adequate ground plane area is essential. The ground plane can be a metal case or ground-fill areas on a circuit board. Ideally, it should have a surface area less than or equal to the overall length of the  $\frac{1}{4}$ -wave radiating element. This is often not practical due to size and configuration constraints. In these instances, a designer must make the best use of the area available to create as much ground

### VERTICAL $\lambda/4$ GROUNDED ANTENNA (MARCONI)

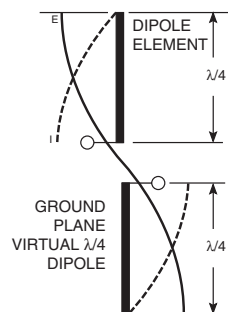

Figure 59: Dipole Antenna

plane as possible in proximity to the base of the antenna. In cases where the antenna is remotely located or the antenna is not in close proximity to a circuit board, ground plane or grounded metal case, a metal plate may be used to maximize the antenna's performance.

5. Remove the antenna as far as possible from potential interference sources. Any frequency of sufficient amplitude to enter the receiver's front end will reduce system range and can even prevent reception entirely. Switching power supplies, oscillators or even relays can also be significant sources of potential interference. The single best weapon against such problems is attention to placement and layout. Filter the module's power supply with a high-frequency bypass capacitor. Place adequate ground plane under potential sources of noise to shunt noise to ground and prevent it from coupling to the RF stage. Shield noisy board areas whenever practical.
6. In some applications, it is advantageous to place the module and antenna away from the main equipment (Figure 60). This can avoid interference problems and allows the antenna to be oriented for optimum performance. Always use  $50\Omega$  coax, like RG-174, for the remote feed.

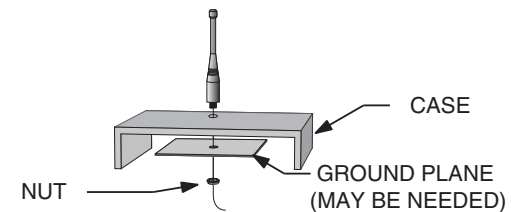

Figure 60: Remote Ground Plane



## Common Antenna Styles

There are hundreds of antenna styles and variations that can be employed with Linx RF modules. Following is a brief discussion of the styles most commonly utilized. Additional antenna information can be found in Linx Application Notes AN-00100, AN-00140, AN-00500 and AN-00501. Linx antennas and connectors offer outstanding performance at a low price.

### Whip Style

A whip style antenna (Figure 61) provides outstanding overall performance and stability. A low-cost whip can be easily fabricated from a wire or rod, but most designers opt for the consistent performance and cosmetic appeal of a professionally-made model. To meet this need, Linx offers a wide variety of straight and reduced height whip style antennas in permanent and connectorized mounting styles.



Figure 61: Whip Style Antennas

The wavelength of the operational frequency determines an antenna's overall length. Since a full wavelength is often quite long, a partial 1/2- or 1/4-wave antenna is normally employed. Its size and natural radiation resistance make it well matched to Linx modules. The proper length for a straight 1/4-wave can be easily determined using the formula in Figure 62. It is also possible to reduce the overall height of the antenna by using a helical winding. This reduces the antenna's bandwidth but is a great way to minimize the antenna's physical size for compact applications. This also means that the physical appearance is not always an indicator of the antenna's frequency.

$$L = \frac{234}{F_{\text{MHz}}}$$

Figure 62:  
L = length in feet of quarter-wave length  
F = operating frequency in megahertz

### Specialty Styles

Linx offers a wide variety of specialized antenna styles (Figure 63). Many of these styles utilize helical elements to reduce the overall antenna size while maintaining reasonable performance. A helical antenna's bandwidth is often quite narrow and the antenna can detune in proximity to other objects, so care must be exercised in layout and placement.



Figure 63: Specialty Style Antennas

### Loop Style

A loop or trace style antenna is normally printed directly on a product's PCB (Figure 64). This makes it the most cost-effective of antenna styles. The element can be made self-resonant or externally resonated with discrete components, but its actual layout is usually product specific. Despite the cost advantages, loop style antennas are generally inefficient and useful only for short range applications. They are also very sensitive to changes in layout and PCB dielectric, which can cause consistency issues during production. In addition, printed styles are difficult to engineer, requiring the use of expensive equipment including a network analyzer. An improperly designed loop will have a high VSWR at the desired frequency which can cause instability in the RF stage.

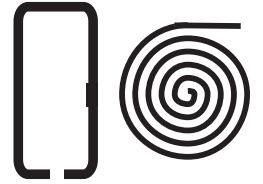

Figure 64: Loop or Trace Antenna

Linx offers low-cost planar (Figure 65) and chip antennas that mount directly to a product's PCB. These tiny antennas do not require testing and provide excellent performance despite their small size. They offer a preferable alternative to the often problematic "printed" antenna.



Figure 65: SP Series "Splatch" and uSP "MicroSplatch" Antennas

## Regulatory Considerations

**Note:** Linx RF modules are designed as component devices that require external components to function. The purchaser understands that additional approvals may be required prior to the sale or operation of the device, and agrees to utilize the component in keeping with all laws governing its use in the country of operation.

When working with RF, a clear distinction must be made between what is technically possible and what is legally acceptable in the country where operation is intended. Many manufacturers have avoided incorporating RF into their products as a result of uncertainty and even fear of the approval and certification process. Here at Linx, our desire is not only to expedite the design process, but also to assist you in achieving a clear idea of what is involved in obtaining the necessary approvals to legally market a completed product.

For information about regulatory approval, read AN-00142 on the Linx website or call Linx. Linx designs products with worldwide regulatory approval in mind.

In the United States, the approval process is actually quite straightforward. The regulations governing RF devices and the enforcement of them are the responsibility of the Federal Communications Commission (FCC). The regulations are contained in Title 47 of the United States Code of Federal Regulations (CFR). Title 47 is made up of numerous volumes; however, all regulations applicable to this module are contained in Volume 0-19. It is strongly recommended that a copy be obtained from the FCC's website, the Government Printing Office in Washington or from your local government bookstore. Excerpts of applicable sections are included with Linx evaluation kits or may be obtained from the Linx Technologies website, [www.linxtechnologies.com](http://www.linxtechnologies.com). In brief, these rules require that any device that intentionally radiates RF energy be approved, that is, tested for compliance and issued a unique identification number. This is a relatively painless process. Final compliance testing is performed by one of the many independent testing laboratories across the country. Many labs can also provide other certifications that the product may require at the same time, such as UL, CLASS A / B, etc. Once the completed product has passed, an ID number is issued that is to be clearly placed on each product manufactured.

Questions regarding interpretations of the Part 2 and Part 15 rules or the measurement procedures used to test intentional radiators such as Linx RF modules for compliance with the technical standards of Part 15 should be addressed to:

Federal Communications Commission  
Equipment Authorization Division  
Customer Service Branch, MS 1300F2  
7435 Oakland Mills Road  
Columbia, MD, US 21046  
Phone: + 1 301 725 585 | Fax: + 1 301 344 2050  
Email: [labinfo@fcc.gov](mailto:labinfo@fcc.gov)

ETSI Secretaria  
650, Route des Lucioles  
06921 Sophia-Antipolis Cedex  
FRANCE  
Phone: +33 (0)4 92 94 42 00  
Fax: +33 (0)4 93 65 47 16

International approvals are slightly more complex, although Linx modules are designed to allow all international standards to be met. If the end product is to be exported to other countries, contact Linx to determine the specific suitability of the module to the application.

All Linx modules are designed with the approval process in mind and thus much of the frustration that is typically experienced with a discrete design is eliminated. Approval is still dependent on many factors, such as the choice of antennas, correct use of the frequency selected and physical packaging. While some extra cost and design effort are required to address these issues, the additional usefulness and profitability added to a product by RF makes the effort more than worthwhile.



Linx Technologies  
159 Ort Lane  
Merlin, OR, US 97532

Phone: +1 541 471 6256  
Fax: +1 541 471 6251

[www.linxtechnologies.com](http://www.linxtechnologies.com)

---

#### Disclaimer

Linx Technologies is continually striving to improve the quality and function of its products. For this reason, we reserve the right to make changes to our products without notice. The information contained in this Data Guide is believed to be accurate as of the time of publication. Specifications are based on representative lot samples. Values may vary from lot-to-lot and are not guaranteed. "Typical" parameters can and do vary over lots and application. Linx Technologies makes no guarantee, warranty, or representation regarding the suitability of any product for use in any specific application. It is the customer's responsibility to verify the suitability of the part for the intended application. **NO LINX PRODUCT IS INTENDED FOR USE IN ANY APPLICATION WHERE THE SAFETY OF LIFE OR PROPERTY IS AT RISK.**

Linx Technologies **DISCLAIMS ALL WARRANTIES OF MERCHANTABILITY AND FITNESS FOR A PARTICULAR PURPOSE. IN NO EVENT SHALL LINX TECHNOLOGIES BE LIABLE FOR ANY OF CUSTOMER'S INCIDENTAL OR CONSEQUENTIAL DAMAGES ARISING IN ANY WAY FROM ANY DEFECTIVE OR NON-CONFORMING PRODUCTS OR FOR ANY OTHER BREACH OF CONTRACT BY LINX TECHNOLOGIES.** The limitations on Linx Technologies' liability are applicable to any and all claims or theories of recovery asserted by Customer, including, without limitation, breach of contract, breach of warranty, strict liability, or negligence. Customer assumes all liability (including, without limitation, liability for injury to person or property, economic loss, or business interruption) for all claims, including claims from third parties, arising from the use of the Products. The Customer will indemnify, defend, protect, and hold harmless Linx Technologies and its officers, employees, subsidiaries, affiliates, distributors, and representatives from and against all claims, damages, actions, suits, proceedings, demands, assessments, adjustments, costs, and expenses incurred by Linx Technologies as a result of or arising from any Products sold by Linx Technologies to Customer. Under no conditions will Linx Technologies be responsible for losses arising from the use or failure of the device in any application, other than the repair, replacement, or refund limited to the original product purchase price. Devices described in this publication may contain proprietary, patented, or copyrighted techniques, components, or materials. Under no circumstances shall any user be conveyed any license or right to the use or ownership of such items.

---

©2016 Linx Technologies. All rights reserved.

The stylized Linx logo, Wireless Made Simple, WISE, CipherLinx and the stylized CL logo are trademarks of Linx Technologies.