

MITSUBISHI IGBT MODULES
CM300DU-24H
 HIGH POWER SWITCHING USE
 INSULATED TYPE

CM300DU-24H



- Ic 300A
- VCES 1200V
- Insulated Type
- 2-elements in a pack
- UL Recognized

Yellow Card No. E80276
 File No. E80271

APPLICATION

UPS, NC machine, AC-Drive control, Servo, Welders

OUTLINE DRAWING & CIRCUIT DIAGRAM

Dimensions in mm

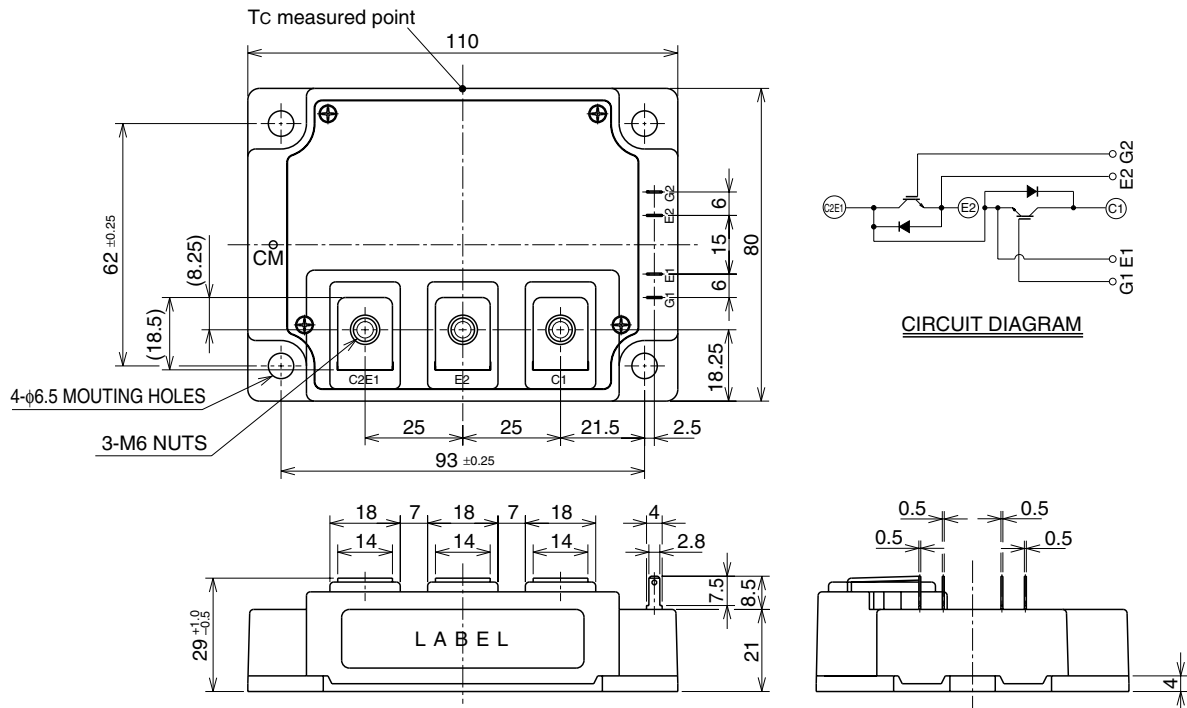

CM300DU-24H

**HIGH POWER SWITCHING USE
INSULATED TYPE**

MAXIMUM RATINGS (T_j = 25°C, unless otherwise specified)

Symbol	Item	Conditions	Ratings	Unit
V _{CEs}	Collector-emitter voltage	V _{GE} = 0V	1200	V
V _{GES}	Gate-emitter voltage	V _{CE} = 0V	±20	V
I _C	Collector current	T _C = 25°C	300	A
I _{CM}		Pulse (Note 1)	600	A
I _E (Note 2)	Emitter current	T _C = 25°C	300	A
I _{EM} (Note 2)		Pulse (Note 1)	600	A
P _C (Note 3)	Maximum collector dissipation	T _C = 25°C	1130	W
T _j	Junction temperature	—	-40 ~ +150	°C
T _{stg}	Storage temperature	—	-40 ~ +125	°C
V _{iso}	Isolation voltage	Charged part to base plate, f = 60Hz, AC 1 minute	2500	V _{rms}
—	Mounting torque	Main terminals M6 screw	3.5 ~ 4.5	N·m
		Mounting M6 screw	3.5 ~ 4.5	N·m
—	Weight	Typical value	580	g

ELECTRICAL CHARACTERISTICS (T_j = 25°C, unless otherwise specified)

Symbol	Item	Test Conditions	Limits			Unit
			Min	Typ	Max	
I _{CES}	Collector cutoff current	V _{CE} = V _{CEs} , V _{GE} = 0V	—	—	1	mA
V _{GE(th)}	Gate-emitter threshold voltage	I _C = 30mA, V _{CE} = 10V	4.5	6	7.5	V
I _{GES}	Gate-leakage current	±V _{GE} = V _{GES} , V _{CE} = 0V	—	—	0.5	μA
V _{CE(sat)}	Collector-emitter saturation voltage	I _C = 300A, V _{GE} = 15V (Note 4)	—	2.9	3.7	V
		T _j = 125°C	—	2.85	—	
C _{ies}	Input capacitance	V _{CE} = 10V	—	—	45	nF
C _{oes}	Output capacitance	V _{GE} = 0V	—	—	15	nF
C _{res}	Reverse transfer capacitance		—	—	9	nF
Q _G	Total gate charge	V _{CC} = 600V, I _C = 300A, V _{GE} = 15V	—	1125	—	nC
t _{d(on)}	Turn-on delay time	V _{CC} = 600V, I _C = 300A	—	—	200	ns
t _r	Turn-on rise time	V _{GE} = ±15V	—	—	300	ns
t _{d(off)}	Turn-off delay time	R _G = 1.0Ω	—	—	350	ns
t _f	Turn-off fall time	Resistive load	—	—	350	ns
V _{EC} (Note 2)	Emitter-collector voltage	I _E = 300A, V _{GE} = 0V	—	—	3.2	V
t _{rr} (Note 2)	Reverse recovery time	I _E = 300A,	—	—	300	ns
Q _{rr} (Note 2)	Reverse recovery charge	die / dt = -600A / μs	—	1.65	—	μC
R _{th(j-c)Q}	Thermal resistance (Note 5)	Junction to case, IGBT part (Per 1/2 module)	—	—	0.11	K/W
R _{th(j-c)R}		Junction to case, FWDi part (Per 1/2 module)	—	—	0.18	K/W
R _{th(c-f)}	Contact thermal resistance	Case to heat sink, conductive grease applied (Per 1/2 module) (Note 6)	—	0.02	—	K/W

- Note 1. Pulse width and repetition rate should be such that the device junction temperature (T_j) does not exceed T_{jmax} rating.
 2. I_E, V_{EC}, t_{rr}, Q_{rr} & die/dt represent characteristics of the anti-parallel, emitter-collector free-wheel diode.
 3. Junction temperature (T_j) should not increase beyond 150°C.
 4. Pulse width and repetition rate should be such as to cause negligible temperature rise.
 5. Case temperature (T_C) measured point is shown in page OUTLINE DRAWING.
 6. Typical value is measured by using thermally conductive grease of λ = 0.9[W/(m · K)].

CM300DU-24H

HIGH POWER SWITCHING USE
INSULATED TYPE

PERFORMANCE CURVES

OUTPUT CHARACTERISTICS (TYPICAL)

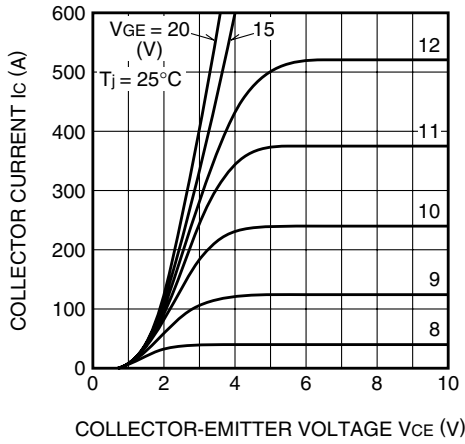

TRANSFER CHARACTERISTICS (TYPICAL)

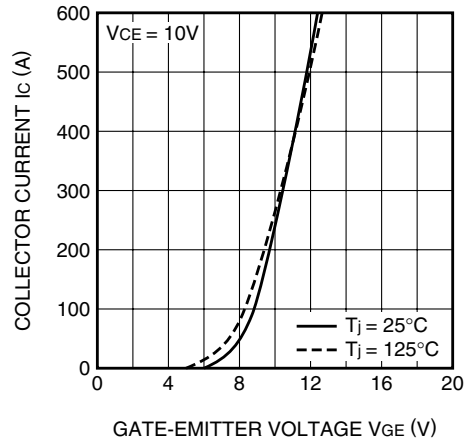

COLLECTOR-EMITTER SATURATION VOLTAGE CHARACTERISTICS (TYPICAL)

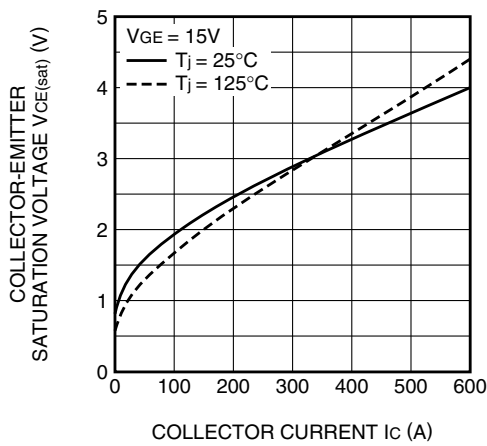

COLLECTOR-EMITTER SATURATION VOLTAGE CHARACTERISTICS (TYPICAL)

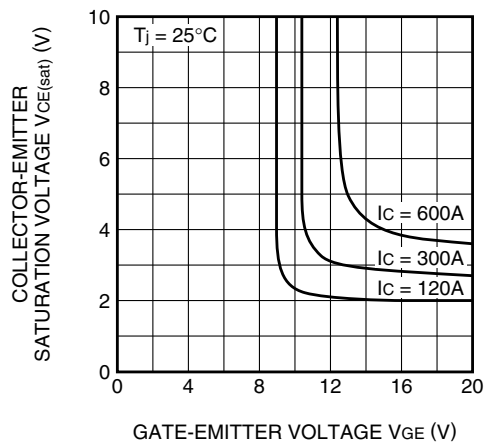

FREE-WHEEL DIODE FORWARD CHARACTERISTICS (TYPICAL)

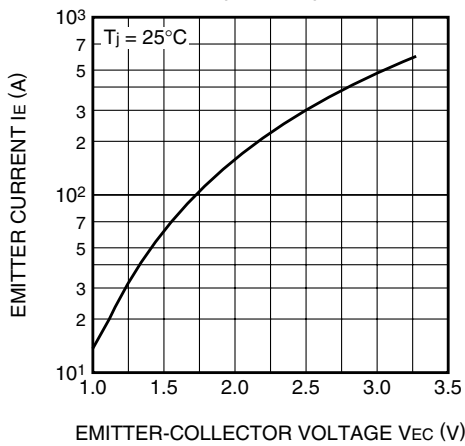

CAPACITANCE CHARACTERISTICS (TYPICAL)

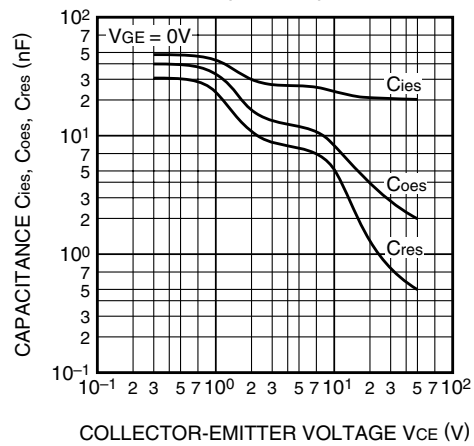

CM300DU-24H

HIGH POWER SWITCHING USE
INSULATED TYPE

HALF-BRIDGE
SWITCHING TIME CHARACTERISTICS
(TYPICAL)

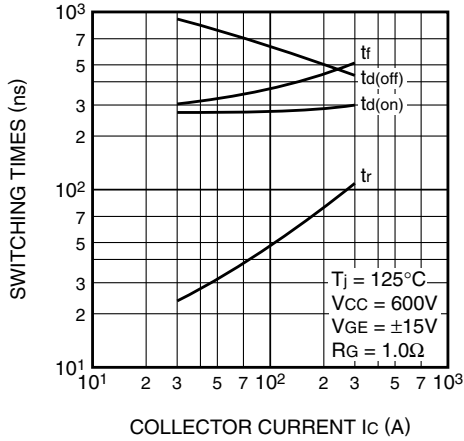

REVERSE RECOVERY CHARACTERISTICS
OF FREE-WHEEL DIODE
(TYPICAL)

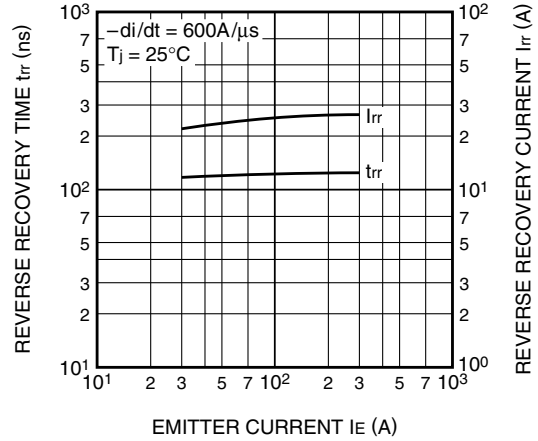

TRANSIENT THERMAL
IMPEDANCE CHARACTERISTICS
(IGBT part)

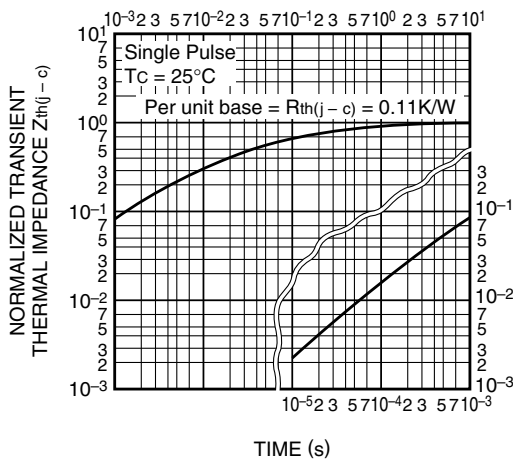

TRANSIENT THERMAL
IMPEDANCE CHARACTERISTICS
(FWDi part)

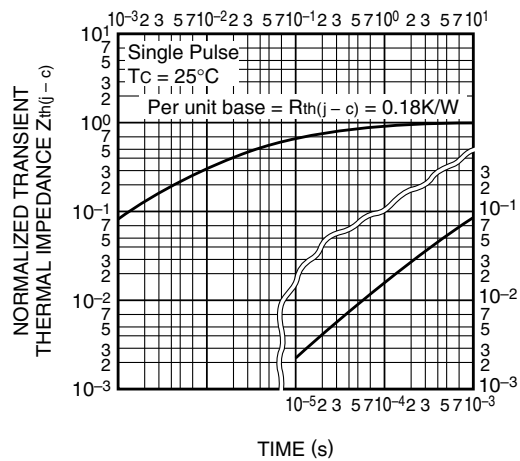

GATE CHARGE CHARACTERISTICS
(TYPICAL)

